

VALOR

SPECIALTY PRODUCTS INC.

BUILDING PRODUCT Guide



Make the ULTIMATE First Impression in your neighbourhood!

www.valor.ca

PRODUCT Index

Section 1 - Shutters

<i>Custom Size Vinyl Shutters</i>	1
<i>Shutter Accessories</i>	2

Section 2 - Fiberglass Columns

<i>Fiberglass Pultruded Columns/Round Tapered</i>	1
<i>Caps, Bases, and Accessories</i>	2

Section 3 - Millwork

<i>PVC Trim Boards</i>	1
<i>PVC Sheets & Accessories</i>	1
<i>PVC Specialty Trims, Corners, Casing, Etc.</i>	2
<i>PVC Notched Fascia, Frieze, & Soffit</i>	2
<i>PVC Extruded Mouldings</i>	3
<i>PVC Siding Accessories</i>	4
<i>PVC Custom Shutters</i>	5
<i>PVC Gable Accents</i>	6 - 10
<i>PVC Square Post Wraps - Straight</i>	11
<i>PVC Square Post Wraps - Tapered</i>	12
<i>PVC Square Column Piers</i>	13
<i>PVC Square Post Wrap Accessories</i>	14
<i>PVC Louvers</i>	15
<i>PVC Wall Accents/Sunbursts</i>	16 - 17
<i>PVC Headers - 5.5" and 7.25"</i>	18
<i>PVC Pilasters</i>	19
<i>PVC Adjustable Pilaster Kits</i>	20
<i>PVC Mouldings</i>	21
<i>PVC Brackets & Accents</i>	22 - 23

Section 4 - Other

<i>Custom PVC Products</i>	1
<i>Paint Services</i>	2



Make the ULTIMATE First Impression in your neighbourhood!

www.valor.ca

VALOR SPECIALTY PRODUCTS INC.
1800 Courtney Park Dr. East, Units 2-4
Mississauga, ON Canada L5T 1W1
TEL: (905) 564-3122 • FAX: (905) 564-5470

VALOR

SPECIALTY PRODUCTS INC.

Custom Size Vinyl Shutters *...made to order*



LOUVER



PANEL

Valor Exterior Decorative Shutters are manufactured from a durable polypropylene compound with the colour moulded right into the plastic. Wood grain texture and beaded detailing give our shutters an elegant look, and are available in many styles to suit virtually any home. Although our shutters are custom made to size; because they are constructed using both extruded and moulded parts it's necessary to pay attention to the minimum and maximum lengths and width availability for each style.



BOARD & BATTEN



HEADERS



PILASTERS



PVC TRIM & SHEETS



Make the ULTIMATE First Impression in your neighbourhood!

www.valor.ca

VALOR SPECIALTY PRODUCTS INC.

1800 Courtneypark Dr. East, Units 2-4

Mississauga, ON Canada L5T 1W1

TEL: (905) 564-3122 • FAX: (905) 564-5470

VALOR

SPECIALTY PRODUCTS INC.

Custom PVC Millwork *...made to order*



Valor Specialty Products Inc. produces one of the broadest ranges of PVC Millwork, allowing us to provide the best product solution. Decorative elements - whether trim, accents, moulding, louvers or full-sized gable pediments - are some of the highest-impact architectural details you can add to a home. Properly selected, they become the aesthetic focal point of design and impact the style and curb appeal of a property. PVC Millwork is more affordable, easier to install, and maintains appeal for decades.



Make the ULTIMATE First Impression in your neighbourhood!

www.valor.ca

VALOR SPECIALTY PRODUCTS INC.

1800 Courtney Park Dr. East, Units 2-4

Mississauga, ON Canada L5T 1W1

TEL: (905) 564-3122 • FAX: (905) 564-5470

Custom Size Vinyl Shutters

...made to order

PRODUCT	STYLE	WIDTHS (IN)	LENGTHS/HEIGHTS (IN)
Louver	A1-A4	9.25, 12.00, 14.50, 16.50*, 18.00*	MIN: 15.00 MAX: 144.00
Louver-Over-Panel	C1-C2	9.25, 12.00, 14.50, 16.50*, 18.00*	MIN: 18.00 MAX: 110.00
One (1) Panel	E1	9.25, 12.00, 14.50, 16.50*, 18.00*	MIN: 18.00 MAX: 55.00
Two (2) Panel	G1	9.25, 12.00, 14.50, 16.50*, 18.00*	MIN: 22.00 MAX: 110.00
Three (3) Panel	J1-J3	9.25, 12.00, 14.50, 16.50*, 18.00*	MIN: 33.00 MAX: 114.00
Board & Batton-Spaced	L	7.75, 12.00, 16.25*, 20.50*	MIN: 18.00 MAX: 144.00
Board & Batton-Joined	M	7.00, 10.50, 14.00*, 17.50*	MIN: 18.00 MAX: 144.00
Board & Batton-Joined Arch Top	M2	14.00	MIN: 45.00 MAX: 94.00

*** Premium Widths**

Shutters Include Screws w/colour matched Plastic Caps

Style: Please SPECIFY Style code when ordering

Widths: ONLY widths listed for each style are available (no custom)

Lengths: ALL shutters may be ordered in 1/4in Increments within the desired Styles listed Min & Max length

Colour: ALL shutters available in ALL available Styles; SPECIFY: Colour Code when ordering

PAINTING: Order Paintable shutters

40 Year Limited Warranty

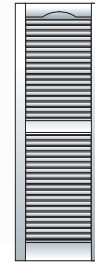

A1
ARCH TOP
w/Centre Bar



A2
STRAIGHT TOP
w/Centre Bar



A3
ARCH TOP
w/o Centre Bar



A4
STRAIGHT TOP
w/o Centre Bar

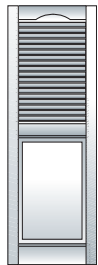

C1
LOUVER OVER
PANEL ARCH TOP



C2
LOUVER OVER PANEL
STRAIGHT TOP



E1
ONE PANEL
STRAIGHT TOP



G1
TWO PANEL
STRAIGHT TOP



J1
EQUAL
SIZE PANELS



J1
SMALLER
MIDDLE PANEL



J1
SMALLER
TOP PANEL



L1
TWO SLATS
SPACED



L1
THREE SLATS
SPACED

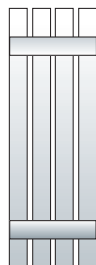

L1
FOUR SLATS
SPACED

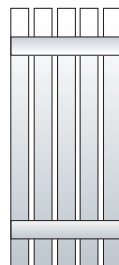

L1
FIVE SLATS
SPACED



M1
TWO SLATS
JOINED



M1
THREE SLATS
JOINED

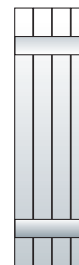

M1
FOUR SLATS
JOINED



M1
FIVE SLATS
JOINED



M2 - ARCHED TOP
FOUR SLATS
JOINED

Make the ULTIMATE First Impression in your neighbourhood!

www.valor.ca

VALOR SPECIALTY PRODUCTS INC.

1800 Courtneypark Dr. East, Units 2-4

Mississauga, ON Canada L5T 1W1

TEL: (905) 564-3122 • FAX: (905) 564-5470

Shutter Accessories



A Quarter Round Tops

- Typically used on round or arch top windows.
- Available only in 14.5" width and 17" height.
- Louvered and Solid styles.
- Colours (see below).
- Not available for Board & Batten style.

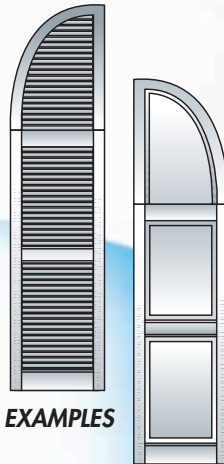

EXAMPLES

B Shutter Lock Plastic Fastener

- Eliminates the need for anchors if installed in masonry material.
- Available in all shutter colours. 12/bag.

C Decorative Hinge & S-Hook

- Replicate the look of old traditional hinged shutters with S-Hooks (or holdback)
- Includes 4 Hinges & 2 S-Hooks
- Available in black only. Hinge & S-Hooks are sold as a kit and cannot be purchased separately.

Quarter Round Tops

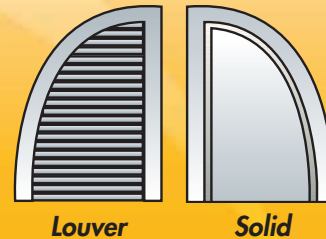

Shutter Lock Plastic Fastener

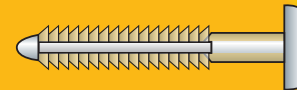

Decorative Hinge & S-Hook

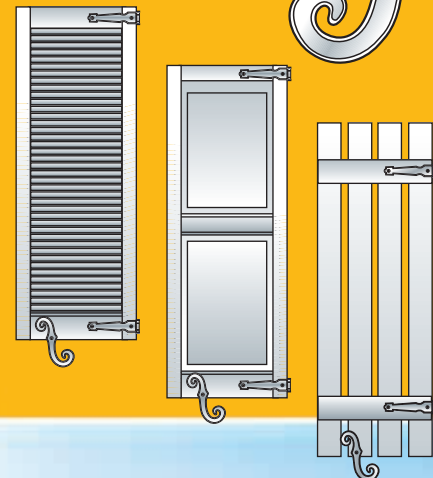

PRODUCT	QUANTITY	LENGTHS/HEIGHTS (IN)
Quarter Round Top - Louver (For Styles A1-C2)	1- Pair	17.00
Quarter Round Top - Solid (For Styles E1-J3)	1- Pair	17.00
Shutter Lock Fastener - Optional	12-EA Colour Matched Plastic	
Hinge & S - Hook	Kit for a single Pair of Shutters	

COLOURS AVAILABLE

WHITE (WH/01)	FOREST GREEN (FG/28)	BORDEAUX (BDX/167)	MIDNIGHT GREEN (MG/122)
BRIGHT WHITE (BWH/117)	BURGUNDY (BU/27)	WICKER (WKR/23)	FEDERAL BROWN (FBR/09)
PAINTABLE (PT/30)	BLACK (BK/02)	CLAY (CL/08)	MUSKET BROWN (MBR/10)
WEDGEWOOD BLUE (WBL/04)	TUXEDO GREY (TGR/18)	CLASSIC BLUE (CB/36)	WINEBERRY (WY/78)
	MIDNIGHT BLUE (MBL/166)		

Make the ULTIMATE First Impression in your neighbourhood!

www.valor.ca

VALOR SPECIALTY PRODUCTS INC.

1800 Courtney Park Dr. East, Units 2-4

Mississauga, ON Canada L5T 1W1

TEL: (905) 564-3122 • FAX: (905) 564-5470



SPECIALTY PRODUCTS INC.

Fiberglass Columns

Pultruded Columns (Load Bearing)

PRODUCT	SIZE (IN)	FITS HEIGHTS (IN)
Square Plain	8.0, 10.0	72, 96, 108, 120, 144
Square Recessed Panel	8.0, 10.0	72, 96, 108, 120, 144
Round - Straight	8.0, 10.0	72, 96, 108, 120, 144

Accessories

PRODUCT	THICKNESS (IN)	FOR FIBERGLASS COLUMN SIZES (IN)	HEIGHTS (IN)
PVC Tuscan Cap	-	8.0, 10.0	-
PVC Tuscan Base	-	8.0, 10.0	-
PVC Square Low Profile Trim	-	8.0, 10.0	-
PVC Square Crown Trim/Cap	-	8.0, 10.0	-
PVC Square Colonial Casing Trim	-	8.0, 10.0	-
PVC Square Colonial Box Trim	-	8.0, 10.0	-
PVC Square Base Cap Trim	-	8.0, 10.0	-
PVC Square OGEE Trim Ring	1	8.0, 10.0	-
PVC Square Trim Ring	3/4, 1	8.0, 10.0	3/4, 1
PVC Square Mounting Skirt	5/8	8.0, 10.0	-
PVC Square Box Cap/Base*	3/4	8.0, 10.0	5.50, 7.25, 9.25, 11.25, 15.25
PVC Square Classic Box Cap/Base	3/4	8.0, 10.0	5.50, 7.25, 9.25, 11.25, 15.25
PVC 1/2in Cap/Base-LINEAL (2-PC)*	1/2	48, 72	3.50
PVC 3/4in Cap/Base-LINEAL (2-PC)*	3/4	48, 72	3.50, 5.50
PVC Square REC Cap Insert (Pack of 4)	5/8	8.0, 10.0	8in: 4.625in / 10in: 5.50in
PVC Square REC Base Insert (Pack of 4)	5/8	8.0, 10.0	8in: 6.125in / 10in: 7.75in
PVC Square REC Centre Insert (Pack of 4)	5/8	8.0, 10.0	8in: 4.625in / 10in: 5.50in
PVC Steel Bracket (Pack of 4)	Galv.		1.25 x 1.50
PVC Steel Bracket (Pack of 100)	Galv.		1.25 x 1.50

* PVC Square (SQR) Box Cap/Base - Edge Options: SQR, CMF, FIL, OGE

Round Tapered Columns (Load Bearing)

PRODUCT	SIZE (IN)	FITS HEIGHTS (IN)
Plain/Smooth	8.0, 10.0, 20.0	60, 72, 96, 120

Accessories

Tuscan Cap & Base Set	For Column Sizes: 8.0, 10.0, 12.0
-----------------------	-----------------------------------

Other sizes available on special orders.



Square (Plain)



Square (Recessed)

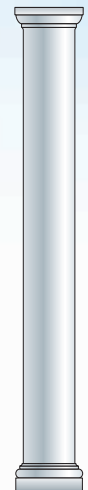

Round (Non-Tapered)



Round Tapered (Smooth-Cast)



Fiberglass columns must be painted
FOR PAINTING INSTRUCTIONS:
 visit www.valor.ca/resources



Make the ULTIMATE First Impression in your neighbourhood!

www.valor.ca

VALOR SPECIALTY PRODUCTS INC.

1800 Courtneypark Dr. East, Units 2-4

Mississauga, ON Canada L5T 1W1

TEL: (905) 564-3122 • FAX: (905) 564-5470

Column Caps, Bases and Accessories

Polyurethane (PU) Tuscan SQR Cap



Polyurethane (PU) Tuscan SQR Base



Colonial Casing Trim (RB3)



Colonial Box Trim (Back Band)



Base Cap Trim Ring



Low Profile Column Trim (Rake)



Low Profile Column Trim (Rake)



PVC Mounting Skirt



OGEE Trim Ring

**Polyurethane (PU)
Tuscan Round Cap**

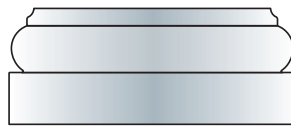
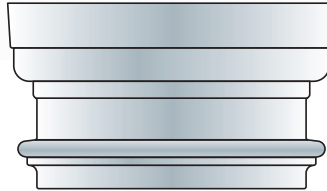

**Polyurethane (PU)
Tuscan Round Base**



PVC SQR Classic Box Cap/Base
Standard Heights:
5.5, 7.25, 9.25, 11.25 & 15.25in.

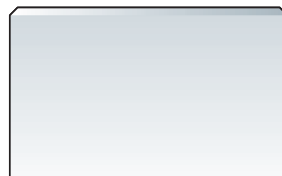

PVC SQR Box Cap/Base
(shown with chamfer)
Standard Heights:
3.5, 5.5, 7.25, 9.25, 11.25in.



Steel Bracket (Galv.)

**Fiberglass Recessed Column
- PVC Cap Insert**

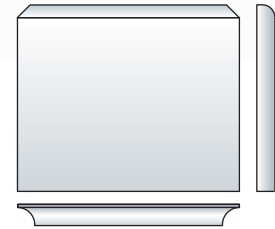

**Fiberglass Recessed Column
- PVC Centre Insert**

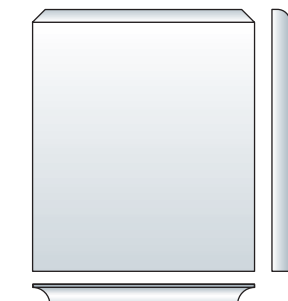

**Fiberglass Recessed Column
- PVC Base Insert**



Crown Trim

PVC Box Cap/Base Edge Options*



OPT: SQR
(Square)



OPT: CMF
(Chamfer)



OPT: FIL
(Fillet)



OPT: OGE
(Ogee)

PVC Trim Boards

THICKNESS (IN)	DENSITY	TEXTURE	STANDARD WIDTHS (IN)	LENGTHS (IN)
1/2 (12mm)	RD	SM/SM	3.50, 5.50, 7.25, 9.25, 11.25	144
5/8 (16mm)	RD	SM/SM	3.50, 5.50, 7.25, 9.25, 11.25	144
3/4 (19mm)	RD	SM/SM	3.50, 5.50, 7.25, 9.25, 11.25	144
	RD	SM/WG	3.50, 5.50, 7.25, 9.25, 11.25	144
	RD	SM/SM	3.50, 5.50, 7.25, 9.25, 11.25	144
1 (25mm)	RD	SM/SM	3.50, 5.50, 7.25, 9.25, 11.25	144
	RD	SM/WG	3.50, 5.50, 7.25, 9.25, 11.25	144

DENSITY: RD - Regular, HD - Heavy
 TEXTURE: SM - Smooth, WG - Woodgrain (Woodgrain applied on 1 side only)
 LENGTHS: Standard 144in (12ft), other Lengths available on request.
Custom sizes and configurations available.

PVC Sheets & Accessories

THICKNESS (IN)	DENSITY	TEXTURE	SHEET SIZES (FT)
3/8 (10mm)	RD	SM/SM	4 x 8, 4 x 12
1/2 (12mm)	RD	SM/SM	4 x 8, 4 x 10, 4 x 12
	RD	SM/WG	4 x 8, 4 x 12
5/8 (16mm)	RD	SM/SM	4 x 8, 4 x 10, 4 x 12, 4 x 16
3/4 (19mm)	RD	SM/SM	4 x 8, 4 x 10, 4 x 12
	RD	SM/WG	4 x 8, 4 x 12
	HD	SM/SM	4 x 8, 4 x 12
1 (25mm)	RD	SM/SM	4 x 8, 4 x 12
	HD	SM/SM	4 x 8, 4 x 12
1-1/4 (32mm)	HD	SM/SM	4 x 8

DENSITY: RD - Regular, HD - Heavy
 TEXTURE: SM - Smooth, WG - Woodgrain (Woodgrain applied on 1 side only)

PRODUCT	LENGTHS (IN)	TEXTURE	PACKAGING (QTY: SCREWS/PLUGS)
Cortex Screw & Plugs	2	Smooth	375/400, 1175/1200
		Woodgrain	375/400
Cortex Screw & Plugs	2-3/4	Smooth	375/400, 1175/1200
		Woodgrain	375/400
Trim Top Screws-Stainless (Painted White)	1-5/8	-	350
	2-1/2	-	350
3M 500FC PU Adhesive - White			300ml Cartridge
3M 4475 Adhesive - Clear			148ml Tube

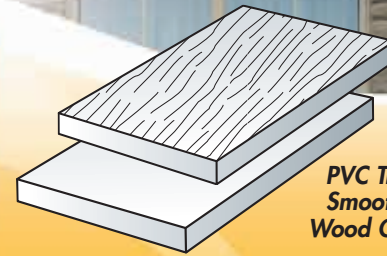

PVC Trimboard Smooth (SM) & Wood Grain (WG)

PVC Trimboard Smooth with Bullnose (BNS)

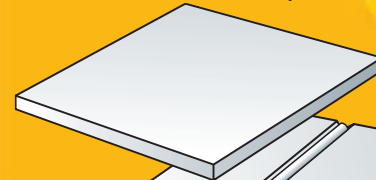
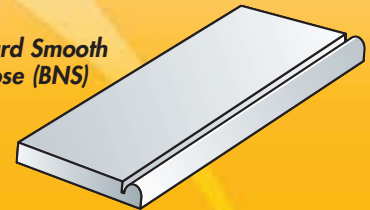

PVC Sheet

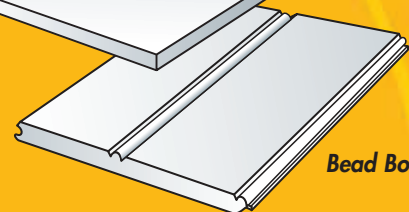

Bead Board



Cortex Screw & Cap



Polyurethane Adhesive Sealant



Tube 150ml Clear Adhesive

Make the ULTIMATE First Impression in your neighbourhood!

www.valor.ca

VALOR SPECIALTY PRODUCTS INC.

1800 Courtneypark Dr. East, Units 2-4

Mississauga, ON Canada L5T 1W1

TEL: (905) 564-3122 • FAX: (905) 564-5470

PVC Specialty Trims, Corners, Casing, Etc.



PRODUCT	THICKNESS (IN)	DENSITY	TEXTURE	STANDARD WIDTHS (IN)	LENGTHS (IN)
TrimBoard-w/Bullnose (BNS)	3/4 (19mm)	RD	SM	3.50, 5.50, 7.25, 9.25, 11.25	144
	1 (25mm)	RD	SM	3.50, 5.50, 7.25, 9.25, 11.25	144
J-Pocket Casing	1 (25mm)	RD	SM	3.50, 5.50, 7.25	96, 144
	1 (25mm)	RD	WG	3.50, 5.50, 7.25	96, 144
Skirtboard	3/4 (19mm)	RD	SM	3.50, 5.50, 7.25	144
	3/4 (19mm)	RD	WG	3.50, 5.50, 7.25	144
	1 (25mm)	RD	SM	3.50, 5.50, 7.25	144
	1 (25mm)	RD	WG	3.50, 5.50, 7.25	144
Outside (O/S) Corner**	3/4 (19mm)	RD	SM	3.50 x 3.50, 5.50 x 5.50	96, 120, 144
	3/4 (19mm)	RD	WG	3.50 x 3.50, 5.50 x 5.50	96, 120, 144
Outside (O/S) Corner	1 (25mm)	RD	SM	3.50 x 3.50, 5.50 x 5.50	96, 120, 144
	1 (25mm)	RD	WG	3.50 x 3.50, 5.50 x 5.50	96, 120, 144
Outside (O/S) Corner - BNS**	3/4 (19mm)	RD	SM	3.50 x 3.50, 5.50 x 5.50	96, 120, 144
	3/4 (19mm)	RD	WG	3.50 x 3.50, 5.50 x 5.50	96, 120, 144
Outside (O/S) Corner - BNS	1 (25mm)	RD	SM	3.50 x 3.50, 5.50 x 5.50	96, 120, 144
	1 (25mm)	RD	WG	3.50 x 3.50, 5.50 x 5.50	96, 120, 144
J-Pocket Outside (O/S) Corner	1 (25mm)	RD	SM	3.50 x 3.50, 5.50 x 5.50	96, 120, 144
	1 (25mm)	RD	WG	3.50 x 3.50, 5.50 x 5.50	96, 120, 144

** Available with NEW Thermoformed Corner.
Custom sizes and configurations available.

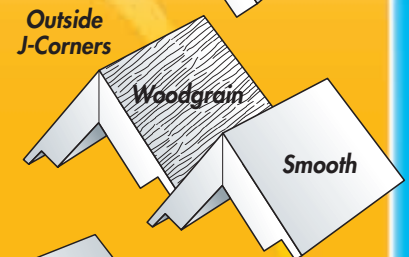
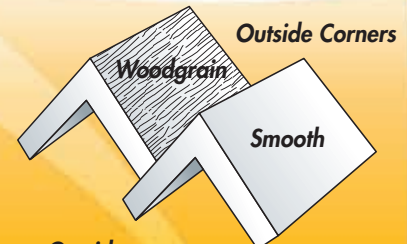

PVC Notched Fascia, Frieze, & Soffit

PRODUCT	THICKNESS (IN)	DENSITY	TEXTURE	STANDARD WIDTHS (IN)	LENGTHS (IN)
Notched Fascia Board	5/8 (16mm)	RD	SM	5.50, 7.25, 9.25	120
	3/4 (19mm)	RD	SM	5.50, 7.25, 9.25	120
Soffit Vented (Typ:01)	1/2 (12mm)	RD	SM	15.25, 23.25	96
T-Mould	5/8 (16mm)	RD	SM	2.50	144

Custom sizes and configurations available.

NEW Thermoform Technology

- Outside Corners
- Fascia Boards
- Beam Cladding
- Columns and more...

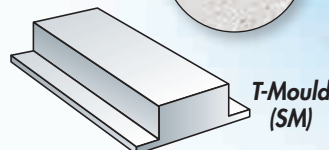
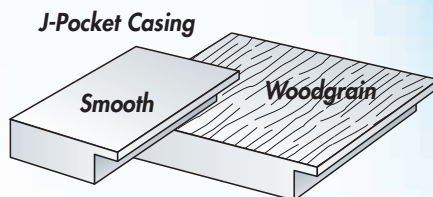
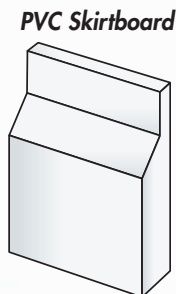
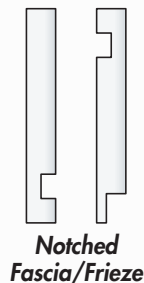

Actual Woodgrain Texture

Make the ULTIMATE First Impression in your neighbourhood!

www.valor.ca

VALOR SPECIALTY PRODUCTS INC.

1800 Courtneypark Dr. East, Units 2-4

Mississauga, ON Canada L5T 1W1

TEL: (905) 564-3122 • FAX: (905) 564-5470

PVC Extruded Mouldings



PRODUCT	THICKNESS (IN)	WIDTHS (IN)	LENGTHS (IN)
5-1/4in Crown (#45)	9/16	5-1/4	192
4-5/8in Crown (#47)	11/16	4-5/8	192
3-5/8in Crown Scant (#49)	9/16	3-5/8	144, 192
2-3/4in Crown Scant (#52)	9/16	2-3/4	192
5-1/4in Crown Cove (#500)	9/16	5-1/4	192
Bed Moulding (#75)	9/16	1-5/8	192
3/4in Quarter Round (#107)	3/4	3/4	192
3/4in Cove	3/4	3/4	192
Base Cap (#164)	11/16	1-1/8	192
Drip Cap (#197)	11/16	1-5/8	192
Shingle Moulding (#210)	11/16	1-5/8	192
Rake Moulding (#287)	1-1/16	2	144, 192
Casing (#356)	11/16	2-1/4	192
Base Board (#623)	9/16	3-1/4	192
Rams Crown	1-13/16	2	192
RB3 Casing	1-7/64	3-7/16	192
1 x 4in Backband	1-3/16	4-1/2	192
Adjustable BackBand	1-11/32	1-13/32	192
Beaded Ceiling Panel	3/8	5-1/2	192
BeadBoard	1/2	5-1/4	192
Shingle Rake 3in	3/4	3	192
Inside Cornerguard	1-1/4	1-1/4	120
Outside Cornerguard	3-1/2	3-1/4	120
Sill Nose	1-3/8	1-5/8	144, 192
New England Sill	1-3/4	2-1/32	144, 192
1.50x1.50in Baluster	1-1/2	1-1/2	192
J-Channel Brickmould	1-1/4	3	120, 144, 204
Brick Mould Flanged	1-1/4	3	120, 144, 204
Brick Mould - Flatblock	1-1/4	2	120, 144, 204

Other lengths available with minimum order quantities, contact us for availability.

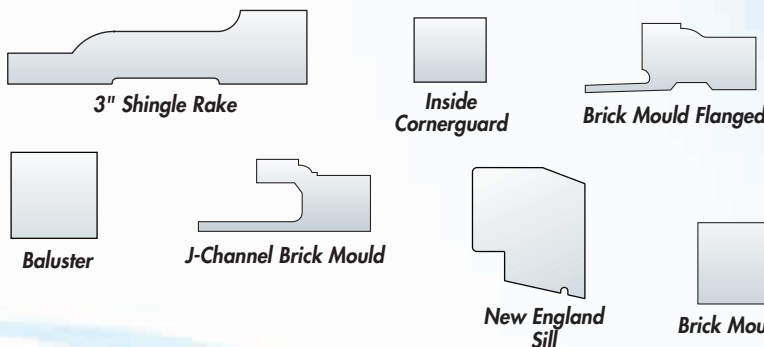
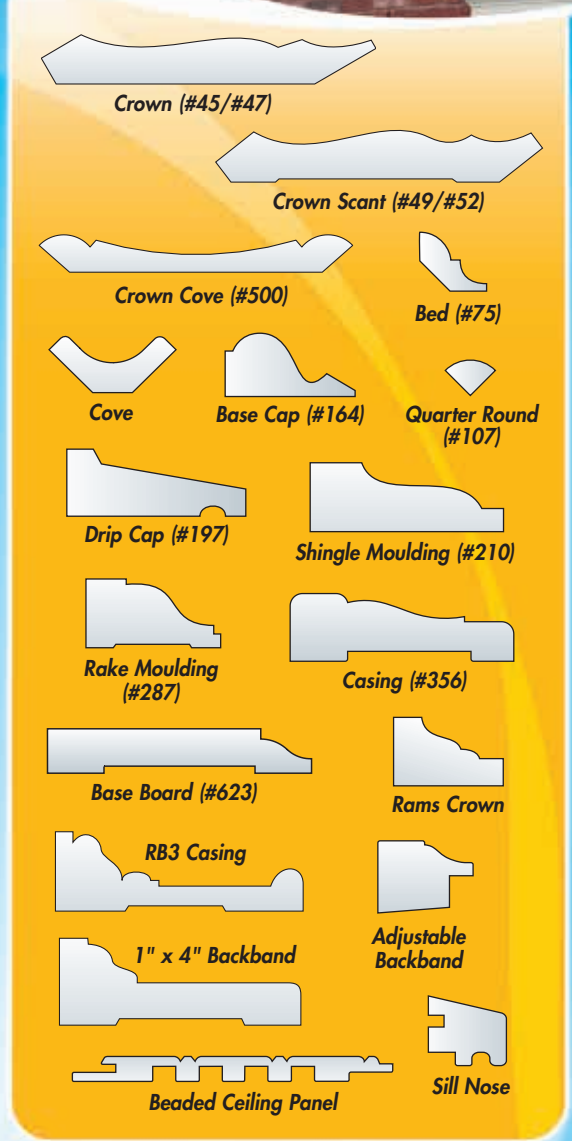

Make the ULTIMATE First Impression in your neighbourhood!

www.valor.ca

VALOR SPECIALTY PRODUCTS INC.

1800 Courtneypark Dr. East, Units 2-4

Mississauga, ON Canada L5T 1W1

TEL: (905) 564-3122 • FAX: (905) 564-5470

PVC Siding Accessories

PRODUCT	THICKNESS (IN)	SIZES (IN)
PVC Block w/1in Centre	0.75	6.5 x 6.5
PVC Block w/1in Center SPLIT	0.75	6.5 x 6.5
PVC Block w/1in Center Single Receptacle	0.75	6.5 x 6.5
PVC Block w/3.5in Centre	0.75	6.5 x 6.5
PVC Block w/3.5in Centre	0.75	6.5 x 8.0
PVC Block w/Cut Outs	0.75	6.5 x 8.0
PVC Block w/3.5in Centre	1.25	6.5 x 6.5
PVC Block w/3.5in Centre	1.25	6.5 x 6.5
PVC Block w/Cut Outs	1.25	6.5 x 6.5
PVC 2-PC Block w/4.25in Center	1.375	9.0 x 9.0
PVC 2-PC Block Single Receptacle	1.375	7.75 x 8.25

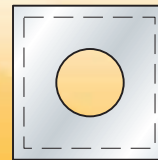

PVC Block
0.75x6.5x6.5in
w/3.5in CTR

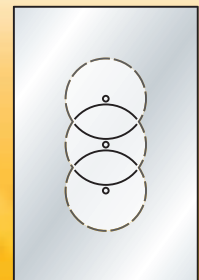

PVC Block
0.75x8.0x12.0in
w/cut outs

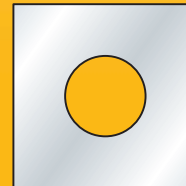

PVC Block
0.75x8.0x8.0in
w/3.5in CTR

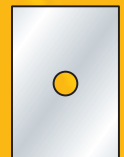

PVC Block
0.75x4.5x6.5in
w/1in CTR

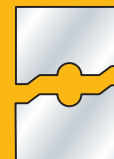
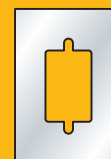

PVC Block
0.75x4.5x6.5in
w/1in CTR Split

PVC Block
0.75x4.5x6.5in
Recess Cut Out

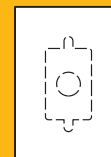

PVC Block
0.75x4.5x6.5in
Receptacle Cut Out



PVC Block
0.75x4.5x6.5in
Recess Solid

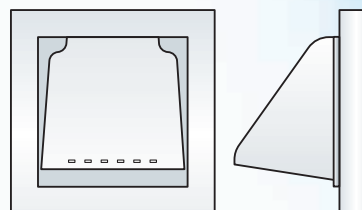

PVC Block Square
0.75x8x8in
w/4" Hooded Exhaust Vent

Make the ULTIMATE First Impression in your neighbourhood!

www.valor.ca

VALOR SPECIALTY PRODUCTS INC.

1800 Courtneypark Dr. East, Units 2-4

Mississauga, ON Canada L5T 1W1

TEL: (905) 564-3122 • FAX: (905) 564-5470



SPECIALTY PRODUCTS INC.

PVC Custom Shutters

...made to order

PRODUCT	STYLE	WIDTHS (IN)	LENGTHS/HEIGHTS (IN)
PVC Closed Louver Shutters	MSH110	12.00, 14.00, 16.00, 18.00, 20.00, 24.00	MIN: 18.00 MAX: 144.00
PVC Recessed Panel Shutters	MSH120	12.00, 14.00, 16.00, 18.00, 20.00, 24.00	MIN: 18.00 MAX: 144.00
PVC Raised Panel (Plunge) Shutters	MSH130	12.00, 14.00, 16.00, 18.00, 20.00, 24.00	MIN: 18.00 MAX: 144.00
PVC Board & Batten Shutters - Joined (3.5in Boards)	MSH140	10.50, 14.00, 17.50, 21.00, 24.50	MIN: 18.00 MAX: 144.00
PVC Board & Batten Shutters - Joined (4.0in Boards)	MSH140	12.00, 16.00, 20.00, 24.00, 28.00	MIN: 18.00 MAX: 144.00
PVC Board & Batten Shutters - Joined w/Diagonal Batten	MSH142	10.50, 14.00, 17.50, 21.00, 24.50	MIN: 18.00 MAX: 144.00
PVC Board & Batten Shutters - Joined w/Diagonal Batten	MSH142	12.00, 16.00, 20.00, 24.00, 28.00	MIN: 18.00 MAX: 144.00
PVC Premium Raised Panel Shutters	MSH150	12.00, 14.00, 16.00, 18.00, 20.00, 24.00	MIN: 18.00 MAX: 144.00
PVC Premium Raised Grooved Panel Shutters	MSH160	12.00, 14.00, 16.00, 18.00, 20.00, 24.00	MIN: 18.00 MAX: 144.00

All Styles Available with ARCH TOP Option

Fasteners: Shutters Include #10x3.0in Screws (12/Pair)

Style: Please SPECIFY Style code when ordering

Widths: Standardized Widths for economical PRICING, Custom widths available

Lengths: ALL shutters may be order inn 1/8in Increments within the desired Styles listed Min & Max length

Colour: ALL shutters sold Unpainted, Special Paint Charges Available for PVC Custom Shutters

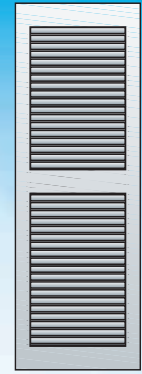

PVC Closed Louver Shutter

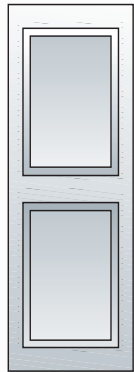

PVC Plunge Routed Panel Shutter

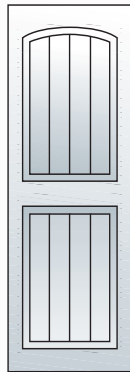

PVC Raised Grooved Panel Shutter

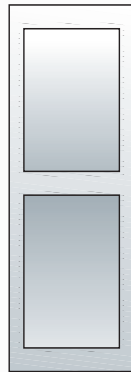

PVC Recessed Panel Shutter

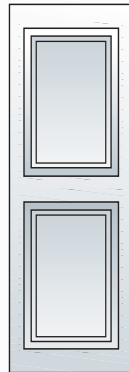

PVC Premium Raised Panel Shutters

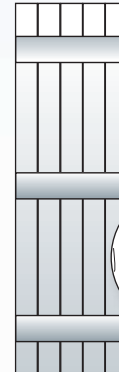

PVC Board & Batten Shutter

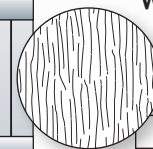

Board & Batten Shutters available in **WOODGRAIN Texture**

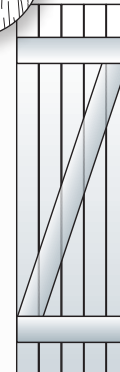

PVC Board & Batten Shutter w/Diagonal Batten

Make the ULTIMATE First Impression in your neighbourhood!

www.valor.ca

VALOR SPECIALTY PRODUCTS INC.

1800 Courtneypark Dr. East, Units 2-4

Mississauga, ON Canada L5T 1W1

TEL: (905) 564-3122 • FAX: (905) 564-5470



SPECIALTY PRODUCTS INC.

PVC Gable Accents

...made to order

PRODUCT DESIGN: Each style has unique elements such as:

- Face Width
- Lamination/Multi layered
- Solid Back/Open Back
- Nail Flange or Jamb/or None
- Some may be cut to conform to a specific Pitch, others are left to fit on site
- Some may have KD (Knock-Down) Options to reduce shipping size and potential damage.

Generally all Elements in a particular style will be left the same regardless of the size ordered. Some elements such as radius' on arch Beam models will use a % of the width to determine the Radius of the beam, and then it may be rounded off. This ensures a consistent look even when small and large Accents the same style are installed on the same house. As a result, some style may not conform well to extreme widths and low pitches, or narrow widths and extreme pitches. In these cases we suggest consulting our office before ordering.

Models MGA-110 to MGA-210

	PITCH																
	5/12	6/12	7/12	8/12	9/12	10/12	11/12	12/12	13/12	14/12	15/12	16/12	17/12	18/12	19/12	20/12	
36	7.50	9.00	10.50	12.00	13.50	15.00	16.50	18.00	19.50	21.00	22.50	24.00	25.50	27.00	28.50	30.00	
42	8.75	10.50	12.25	14.00	15.75	17.50	19.25	21.00	22.75	24.50	26.25	28.00	29.75	31.50	33.25	35.00	
48	10.00	12.00	14.00	16.00	18.00	20.00	22.00	24.00	26.00	28.00	30.00	32.00	34.00	36.00	38.00	40.00	
54	11.25	13.50	15.75	18.00	20.25	22.50	24.75	27.00	29.25	31.50	33.75	36.00	38.25	40.50	42.75	45.00	
60	12.50	15.00	17.50	20.00	22.50	25.00	27.50	30.00	32.50	35.00	37.50	40.00	42.50	45.00	47.50	50.00	
66	13.75	16.50	19.25	22.00	24.75	27.50	30.25	33.00	35.75	38.50	41.25	44.00	46.75	49.50	52.25	55.00	
72	15.00	18.00	21.00	24.00	27.00	30.00	33.00	36.00	39.00	42.00	45.00	48.00	51.00	54.00	57.00	60.00	
78	16.25	19.50	22.75	26.00	29.25	32.50	35.75	39.00	42.25	45.50	48.75	52.00	55.25	58.50	61.75	65.00	
84	17.50	21.00	24.50	28.00	31.50	35.00	38.50	42.00	45.50	49.00	52.50	56.00	59.50	63.00	66.50	70.00	
90	18.75	22.50	26.25	30.00	33.75	37.50	41.25	45.00	48.75	52.50	56.25	60.00	63.75	67.50	71.25	75.00	
96	20.00	24.00	28.00	32.00	36.00	40.00	44.00	48.00	52.00	56.00	60.00	64.00	68.00	72.00	76.00	80.00	
102	21.25	25.50	29.75	34.00	38.25	42.50	46.75	51.00	55.25	59.50	63.75	68.00	72.25	76.50	80.75	85.00	
108	22.50	27.00	31.50	36.00	40.50	45.00	49.50	54.00	58.50	63.00	67.50	72.00	76.50	81.00	85.50	90.00	
114	23.75	28.50	33.25	38.00	42.75	47.50	52.25	57.00	61.75	66.50	71.25	76.00	80.75	85.50	90.25	95.00	
120	25.00	30.00	35.00	40.00	45.00	50.00	55.00	60.00	65.00	70.00	75.00	80.00	85.00	90.00	95.00	100.00	

Make the ULTIMATE First Impression in your neighbourhood!

www.valor.ca

VALOR SPECIALTY PRODUCTS INC.

1800 Courtneypark Dr. East, Units 2-4

Mississauga, ON Canada L5T 1W1

TEL: (905) 564-3122 • FAX: (905) 564-5470

PVC Gable Accents

...made to order

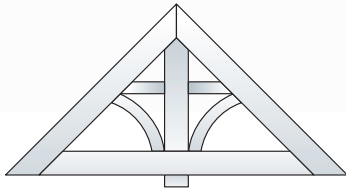

MGA-110

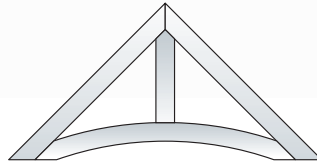

MGA-112

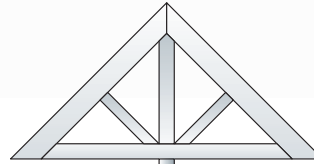

MGA-115

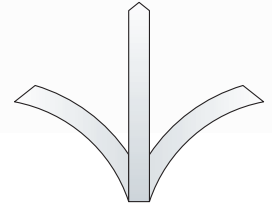

MGA-118

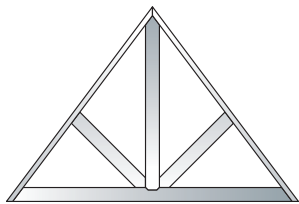

MGA-120

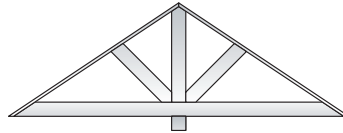

MGA-125

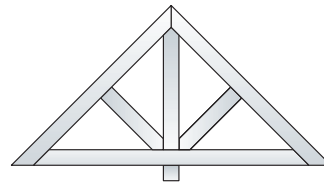

MGA-126

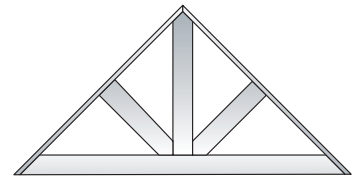

MGA-130

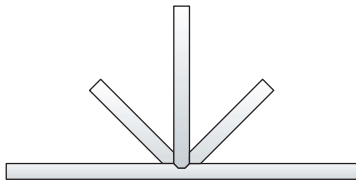

MGA-132

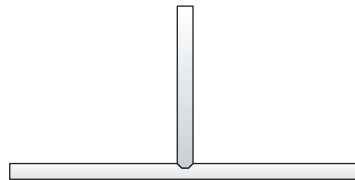

MGA-133

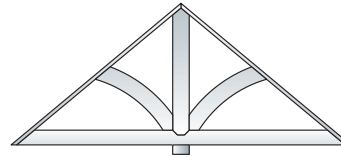

MGA-135

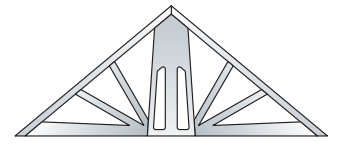

MGA-140

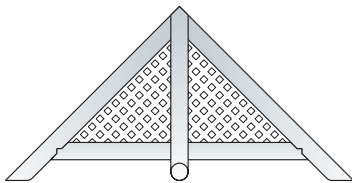

MGA-145

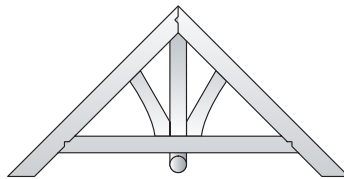

MGA-150

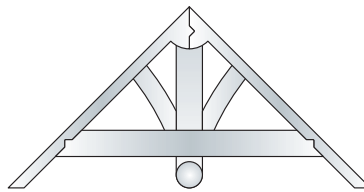

MGA-152

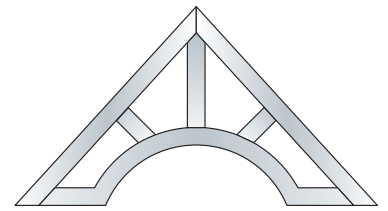

MGA-155

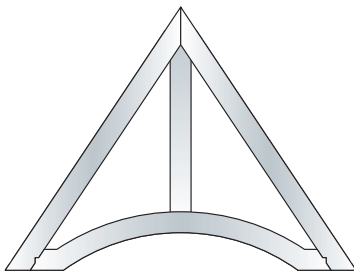

MGA-157

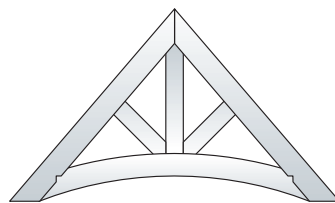

MGA-160

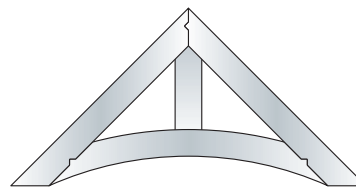

MGA-161

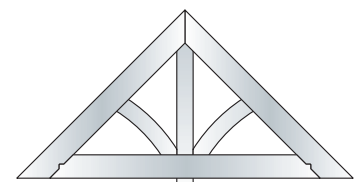

MGA-162

Make the ULTIMATE First Impression in your neighbourhood!

www.valor.ca

VALOR SPECIALTY PRODUCTS INC.

1800 Courtneypark Dr. East, Units 2-4

Mississauga, ON Canada L5T 1W1

TEL: (905) 564-3122 • FAX: (905) 564-5470

PVC Gable Accents

...made to order

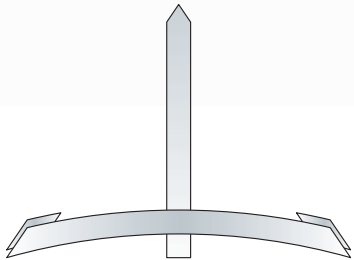

MGA-165

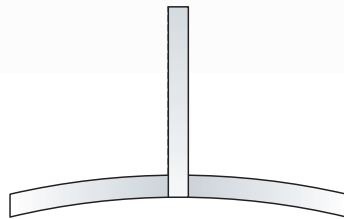

MGA-166

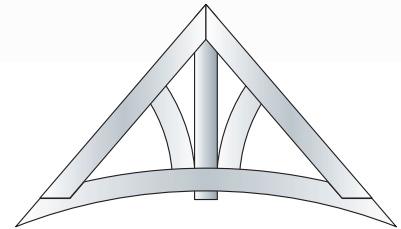

MGA-167

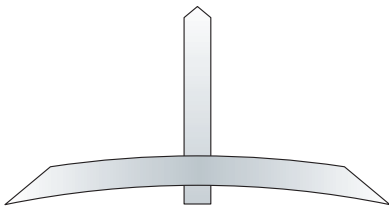

MGA-168

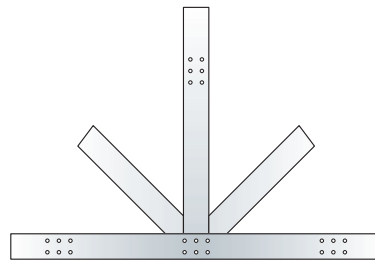

MGA-169

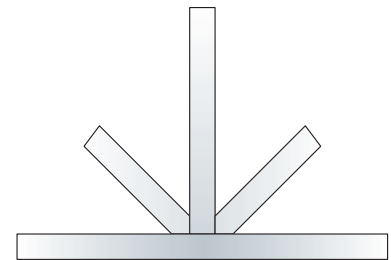

MGA-170

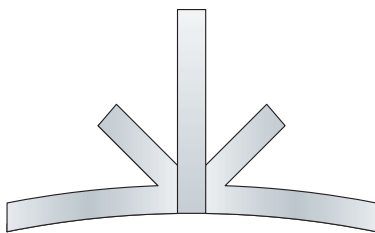

MGA-171

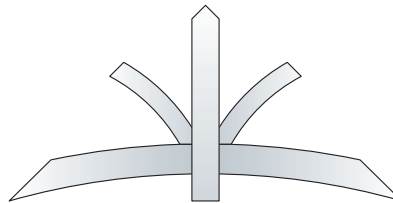

MGA-172

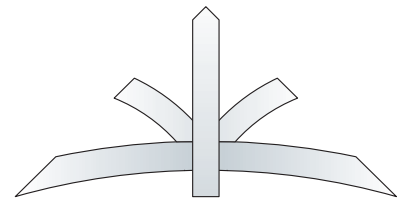

MGA-173

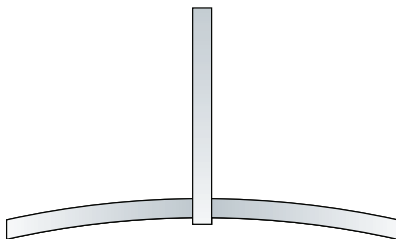

MGA-174

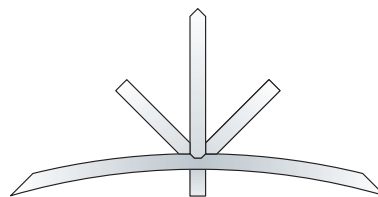

MGA-175

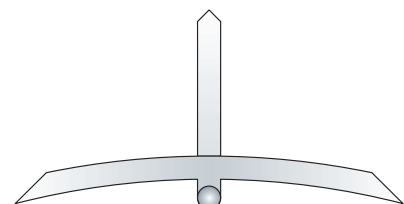

MGA-176

Make the ULTIMATE First Impression in your neighbourhood!

www.valor.ca

VALOR SPECIALTY PRODUCTS INC.

1800 Courtneypark Dr. East, Units 2-4

Mississauga, ON Canada L5T 1W1

TEL: (905) 564-3122 • FAX: (905) 564-5470

PVC Gable Accents

...made to order

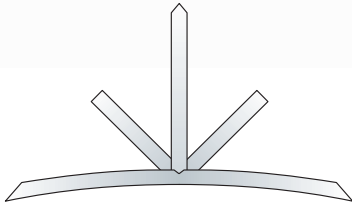

MGA-178

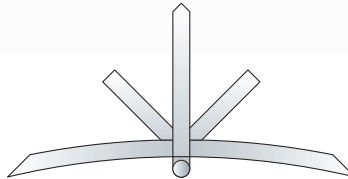

MGA-179

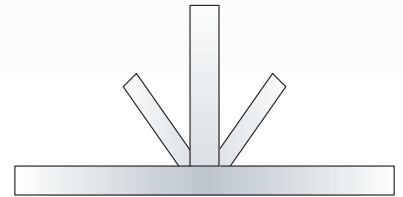

MGA-180

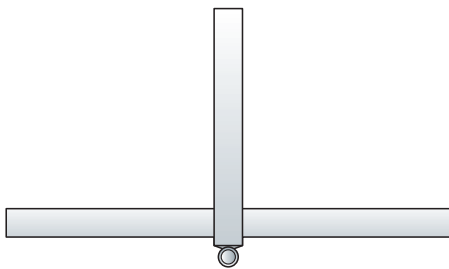

MGA-181

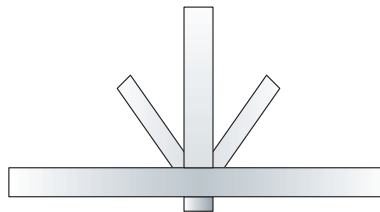

MGA-182

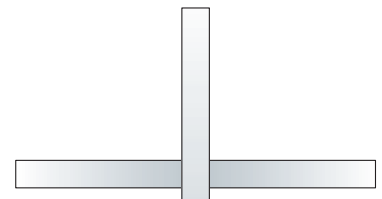

MGA-183

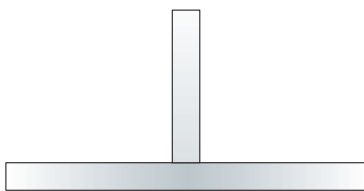

MGA-185

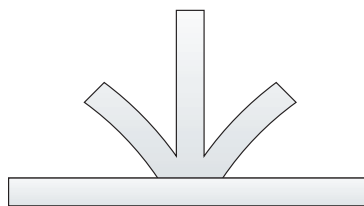

MGA-186

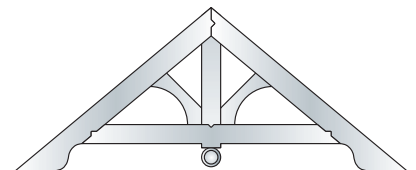

MGA-190

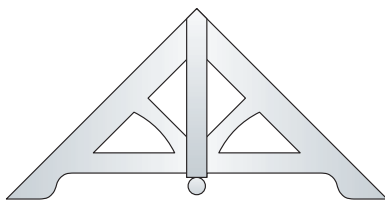

MGA-192

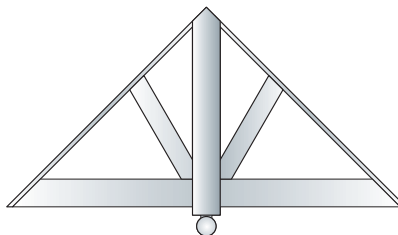

MGA-200

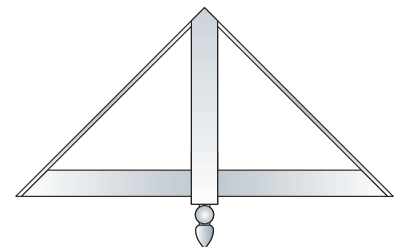

MGA-210

Make the ULTIMATE First Impression in your neighbourhood!

www.valor.ca

VALOR SPECIALTY PRODUCTS INC.

1800 Courtneypark Dr. East, Units 2-4

Mississauga, ON Canada L5T 1W1

TEL: (905) 564-3122 • FAX: (905) 564-5470

PVC Gable Accents

Standard Sizes & Knock Down Models

PRODUCT	PITCH	HEIGHTS (IN)	WIDTHS (IN)
MGA-500 Accent (Cut to Pitch)	9/12	33.00	84.00
	16/12	42.75	63.00
MGA-510 Accent (Cut to Pitch)	9/12	33.00	84.00
	16/12	42.75	63.00
MGA-630 Accent (Cut to size)	9/12	33.00	84.00
Sold w/Jamb	16/12	42.75	63.00
MGA-692 Accent (Cut to size)	9/12	33.00	84.00
	16/12	42.75	63.00
MGA-668 Accent (Cut to size)	9/12	33.00	84.00
	16/12	42.75	63.00

* **PREMIUMS** Charged for Custom & Extra Large Sizes.
 SQR-Square Bottom Edge, BNS-Bullnose Bottom Edge
 Thickness: Base, TTL-Total Projection
 Custom sizes available.

PVC Gable Posts

PRODUCT	TYPE	SIZES (IN)	HEIGHTS (IN)
MGA-Gable Post w/Round	1	2.50 x 2.50	36, 42
MGA-Gable Post w/Round	2	3.50 x 3.50	36, 42
MGA-SQR Gable Post	3	3.50 x 3.50	36, 42, 60
MGA-SQR Gable Post	4	3.50 x 3.50	36, 42, 60

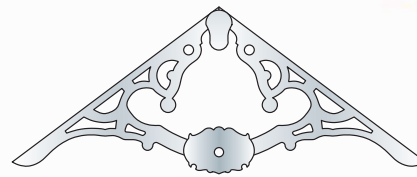

MGA-500

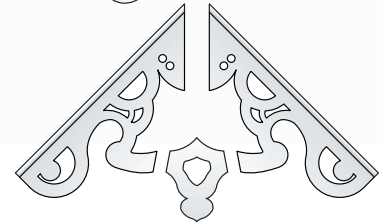

MGA-510

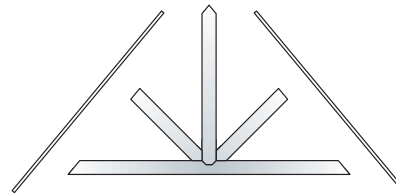

MGA-630

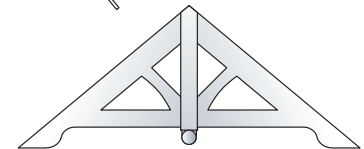

MGA-692

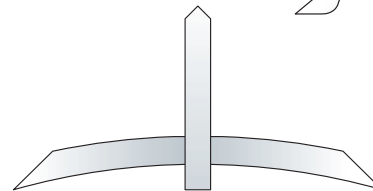

MGA-668

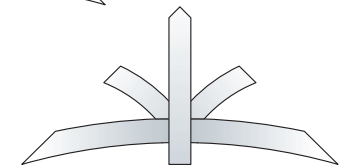

MGA-673



Type: 01
2.50"
Gable Post



Type: 02
3.50"
Gable Post

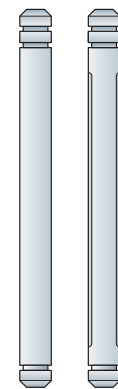

Type: 03/04
3.50"
Gable Post

Make the ULTIMATE First Impression in your neighbourhood!

www.valor.ca

VALOR SPECIALTY PRODUCTS INC.

1800 Courtneypark Dr. East, Units 2-4

Mississauga, ON Canada L5T 1W1

TEL: (905) 564-3122 • FAX: (905) 564-5470



SPECIALTY PRODUCTS INC.

PVC Square Post Wraps - Straight

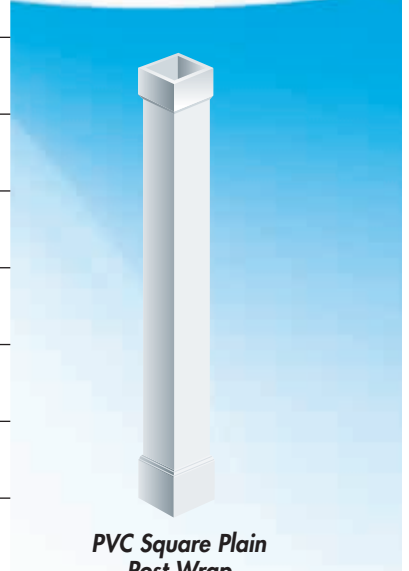

PVC Square Plain Post Wrap

PRODUCT	TYPE (TYP)	THICKNESS (IN)	DIMENSIONS (IN)					HEIGHTS (IN)	
PVC Square - Plain	PLN	1/2	Outside:	5.50	7.25	9.25	11.25	15.25	48, 60, 72, 84, 96, 108, 120, 144
			Inside:	4.50	6.25	8.25	10.25	14.25	
PVC Square - Plain	PLN	5/8	Outside:	5.50	7.25	9.25	11.25	15.25	48, 60, 72, 84, 96, 108, 120, 144
			Inside:	4.25	6.00	8.00	10.00	14.00	
PVC Square - Fluted	FLT01	5/8	Outside:	5.50	7.25	9.25	11.25	15.25	48, 60, 72, 84, 96, 108, 120, 144
			Inside:	4.25	6.00	8.00	10.00	14.00	
	FLT02	5/8	Outside:	5.50	7.25	9.25	11.25	15.25	48, 60, 72, 84, 96, 108, 120, 144
Inside:	4.25	6.00	8.00	10.00	14.00				
PVC Square - Fluted	FLT03	5/8	Outside:	5.50	7.25	9.25	11.25	15.25	48, 60, 72, 84, 96, 108, 120, 144
			Inside:	4.25	6.00	8.00	10.00	14.00	
	RPL01	5/8	Outside:	5.50	7.25	9.25	11.25	15.25	48, 60, 72, 84, 96, 108, 120, 144
Inside:	4.25	6.00	8.00	10.00	14.00				
PVC Square - Raised Panel	RPL02	5/8	Outside:	5.50	7.25	9.25	11.25	15.25	48, 60, 72, 84, 96, 108, 120, 144
			Inside:	4.25	6.00	8.00	10.00	14.00	
	RPL03	5/8	Outside:	5.50	7.25	9.25	11.25	15.25	48, 60, 72, 84, 96, 108, 120, 144
Inside:	4.25	6.00	8.00	10.00	14.00				
PVC Square - Recessed Panel	RECO1	5/8	Outside:	5.50	7.25	9.25	11.25	15.25	48, 60, 72, 84, 96, 108, 120, 144
			Inside:	4.25	6.00	8.00	10.00	14.00	
	RECO2	5/8	Outside:	5.50	7.25	9.25	11.25	15.25	48, 60, 72, 84, 96, 108, 120, 144
Inside:	4.25	6.00	8.00	10.00	14.00				
PVC Square - Recessed Panel	RECO3	5/8	Outside:	5.50	7.25	9.25	11.25	15.25	48, 60, 72, 84, 96, 108, 120, 144
			Inside:	4.25	6.00	8.00	10.00	14.00	

Post wraps above do not include Caps or Bases.

IMPORTANT NOTE Post Wraps can be sold in three different formats: A) KD (Knock-Down/ Unassembled) B) Split-"L" (2-L sections) C) U-Construction, where the Wrap is assembled with a single Panel Loose (removable) to allow it to be installed around a post. ALL orders will be produced in a KD-Format unless otherwise specified on your order.
NOTE: The KD format is the preferred method if the product is being shipped, as they take less room and are therefore cheaper to ship, and are less prone to damage. SPLIT "L" or U-Construction formats may require additional packaging and shipping premiums applied.

PVC Square Fluted Straight Post Wraps

PVC Square Raised Panel Straight Wraps

PVC Square Recessed Panel Straight Wraps

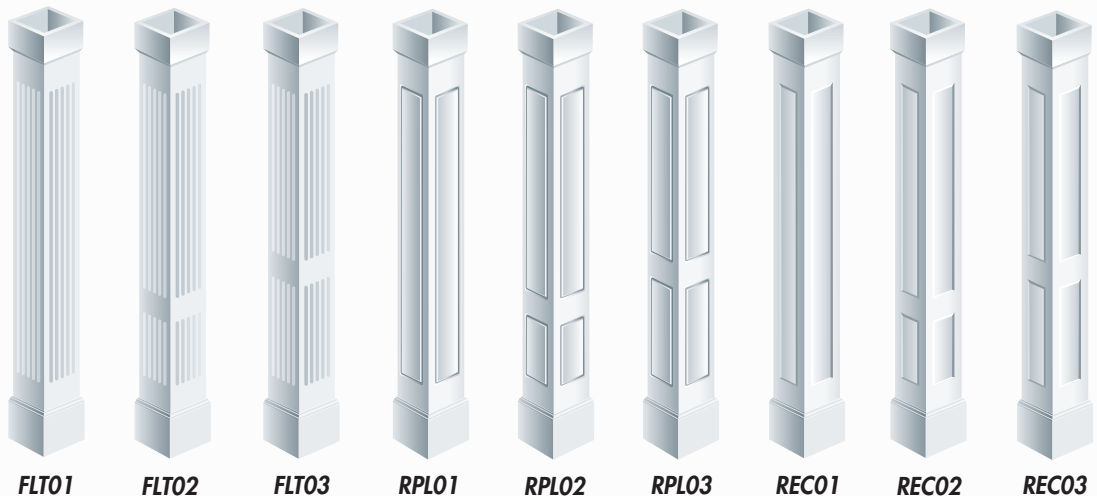

Make the ULTIMATE First Impression in your neighbourhood!

www.valor.ca

VALOR SPECIALTY PRODUCTS INC.

1800 Courtneypark Dr. East, Units 2-4

Mississauga, ON Canada L5T 1W1

TEL: (905) 564-3122 • FAX: (905) 564-5470



SPECIALTY PRODUCTS INC.

PVC Square Post Wraps - Tapered

PRODUCT	TYPE (TYP)	THICKNESS (IN)	DIMENSIONS (IN)				HEIGHTS (IN)	
PVC Square Tapered - Plain	PLN	1/2	Outside:	6x10	8x12	10x14	12x16	48, 60, 72, 84, 96, 108, 120, 144
			Inside:	5x9	7x11	9x13	11x15	
PVC Square Tapered - Raised Panel	RPL01	5/8	Outside:	6x10	8x12	10x14	12x16	48, 60, 72, 84, 96, 108, 120, 144
			Inside:	4.75x8.75	6.75x10.75	8.75x12.75	10.75x14.75	
PVC Square Tapered - Recessed Panel	RECO1	5/8	Outside:	6x10	8x12	10x14	12x16	48, 60, 72, 84, 96, 108, 120, 144
			Inside:	4.75x8.75	6.75x10.75	8.75x12.75	10.75x14.75	

Post wraps above do not include Caps or Bases.

IMPORTANT NOTE

Post Wraps can be sold in three different formats: A) KD (Knock-Down/Unassembled) B) Split-"L" (2-L sections) C) U-Construction, where the Wrap is assembled with a single Panel Loose (removable) to allow it to be installed around a post. ALL orders will be produced in a KD-Format unless otherwise specified on your order. NOTE: The KD format is the preferred method if the product is being shipped, as they take less room and are therefore cheaper to ship, and are less prone to damage. SPLIT "L" or U-Construction formats may require additional packaging and shipping premiums applied.



PVC Square Tapered Plain Column Wrap PLN



PVC Square Tapered Recessed Panel Column Wrap RECO1



PVC Square Tapered Raised Panel Column Wrap RPL01

Make the ULTIMATE First Impression in your neighbourhood!

www.valor.ca

VALOR SPECIALTY PRODUCTS INC.

1800 Courtneypark Dr. East, Units 2-4

Mississauga, ON Canada L5T 1W1

TEL: (905) 564-3122 • FAX: (905) 564-5470



SPECIALTY PRODUCTS INC.

PVC Square Half Column Piers

- Piers are designed to wrap our Standard Square Load Bearing Columns
- Piers can be shipped as a full assembled Sleeve, or KD.
- Internal Spacers conform the Size Column you wish to use it with.
- Choose an appropriate cap for your application.

PRODUCT	TYPE (TYP)	THICKNESS (IN)	SIZES (IN)	HEIGHTS (IN)
PVC Square Plain	PLN	5/8	11.25, 15.25, 20.25, 23.25	38, 44
PVC Square - Fluted	FLT01	5/8	11.25, 15.25, 20.25, 23.25	38, 44
PVC Square - Raised Panel	RPL01	5/8	11.25, 15.25, 20.25, 23.25	38, 44
PVC Square - Recessed Panel	RECO1	5/8	11.25, 15.25, 20.25, 23.25	38, 44
PVC Pier Cap (Typ:01)*	-	-	12.75x12.75, 16.75x16.75, 21.75x21.75, 24.75x24.75	3/4
PVC Pier Cap (Typ:02)*	-	-	12.75x12.75, 16.75x16.75, 21.75x21.75, 24.75x24.75	2-1/4

* Choose Available Edge Option
Custom sizes available.



PVC Square Fluted Panel



PVC Square Raised Panel



PVC Square Recessed Panel

PVC Pier Cap Type Thickness



Typ: 01



Typ: 02

*Pier Caps can be cut to allow for structural posts.

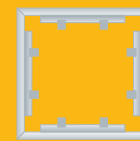

Top Cap

PVC Box Cap/Base Edge Options



OPT: SQR (Square)



OPT: CMF (Chamfer)



OPT: FIL (Fillet)



OPT: OGE (Ogee)

Make the ULTIMATE First Impression in your neighbourhood!

www.valor.ca

VALOR SPECIALTY PRODUCTS INC.

1800 Courtneypark Dr. East, Units 2-4

Mississauga, ON Canada L5T 1W1

TEL: (905) 564-3122 • FAX: (905) 564-5470



SPECIALTY PRODUCTS INC.

PVC Square Post Wrap Accessories

PRODUCT	THICKNESS (IN)	INSIDE DIMENSIONS (IN)	HEIGHTS (IN)
PVC Square Low Profile Trim	-	5.50, 7.25, 9.25, 11.25, 15.25	-
PVC Square Crown Trim/Cap	-	5.50, 7.25, 9.25, 11.25, 15.25	-
PVC Square Colonial Casing Trim	-	5.50, 7.25, 9.25, 11.25, 15.25	-
PVC Square Colonial Box Trim	-	5.50, 7.25, 9.25, 11.25, 15.25	-
PVC Square Base Cap Trim	-	5.50, 7.25, 9.25, 11.25, 15.25	-
PVC Square OGEE Trim Ring	1	5.50, 7.25, 9.25, 11.25, 15.25	-
PVC Square Trim Ring	3/4, 1	5.50, 7.25, 9.25, 11.25, 15.25	3/4, 1
PVC Square Mounting Skirt	5/8	5.50, 7.25, 9.25, 11.25, 15.25	-
PVC Square Box Cap/Base*	3/4	5.50, 7.25, 9.25, 11.25, 15.25	5.50, 7.25, 9.25, 11.25, 15.25
PVC Square Classic Box Cap/Base	3/4	5.50, 7.25, 9.25, 11.25, 15.25	5.50, 7.25, 9.25, 11.25, 15.25
PVC Low Profile Tapered Column Trim - KIT (4-PC)	3/4	8, 10, 12, 16	-
PVC 1/2in Cap/Base-LINEAL (2-PC)*	1/2	48, 72	3.50
PVC 3/4in Cap/Base-LINEAL (2-PC)*	3/4	48, 72	3.50, 5.50

* PVC Square (SQR) Box Cap/Base - Edge Options: SQR, CMF, FIL, OGE



OGEE Trim Ring



Crown Cap



Base Cap Trim Ring

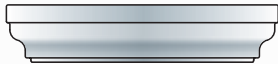

Low Profile Column Trim (Rake)



Low Profile Column Trim (Rake)

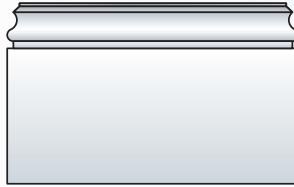

PVC SQR Classic Box Cap/Base
Standard Heights:
5.5, 7.25, 9.25, 11.25 & 15.25in.

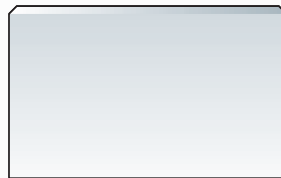

PVC SQR Box Cap/Base
(shown with chamfer)
Standard Heights:
3.5, 5.5, 7.25, 9.25, 11.25in.



Colonial Casing Trim (RB3)



Colonial Box Trim (Back Band)



Post Wrap Install Kit
Incl: 1 ea. - Tube 150ml Adhesive
36ea. - 1x6in Tape Tabs

* PVC Box Cap/Base Edge Options



OPT: SQR
(Square)



OPT: CMF
(Chamfer)



OPT: FIL
(Fillet)



OPT: OGE
(Ogee)

Make the ULTIMATE First Impression in your neighbourhood!

www.valor.ca

VALOR SPECIALTY PRODUCTS INC.

1800 Courtneypark Dr. East, Units 2-4

Mississauga, ON Canada L5T 1W1

TEL: (905) 564-3122 • FAX: (905) 564-5470

PVC Louvers

PRODUCT	FORMAT	THICKNESS (IN)	HEIGHTS (IN)
PVC Octagon (Typ:01)	NF-Solid	1.5	16, 18, 20, 24, 28, 30, 32, 36, 40, 42, 44
PVC Round (Typ:01)	NF-Solid	1.5	16, 18, 20, 24, 28, 30, 32, 36, 40, 42, 44
PVC Round Top (Typ:01)	NF-Solid	1.5	10 x 16, 12 x 18, 14 x 22, 16 x 24, 18 x 28, 20 x 30, 22 x 34, 24 x 38, 28 x 42, 32 x 48, 36 x 54
PVC Half Round (Typ:01)	NF-Solid	1.5	14 x 20, 16 x 24, 18 x 28, 20 x 32, 22 x 36, 24 x 40, 26 x 44, 28 x 48, 30 x 52, 34 x 60, 40 x 72
PVC Rectangular (Typ:01)	NF-Solid	1.5	10 x 16, 12 x 18, 14 x 22, 16 x 24, 18 x 28, 20 x 30, 24 x 36, 30 x 46, 36 x 54, 40 x 60, 42 x 64
PVC Rectangular (Typ:03) w/Brick Mould	NF-Solid	1.5	12 x 24, 16 x 24, 16 x 36, 18 x 30, 24 x 24, 24 x 48
PVC Square (Typ:01)	NF-Solid	1.5	10, 12, 14, 16, 18, 20, 24, 30, 36, 40, 42
PVC Oval (Typ:01)	NF-Solid	1.5	12 x 18, 14 x 20, 16 x 24, 18 x 26, 22 x 32, 28 x 40, 32 x 48
PVC Triangular (Typ:01)	NF-Solid	1.5	Pitches: From 5/12 - 24/12 Widths: 36 - 144*

*PREMIUMS Charged for Custom & Extra Large Sizes.

NF= Non-Functional
Solid=Solid PVC Construction
Custom sizes available.

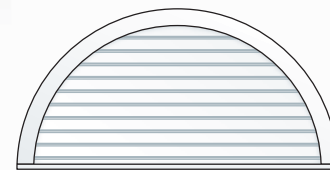
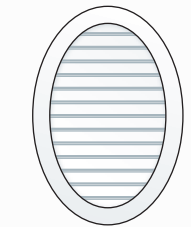
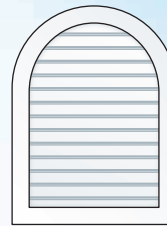
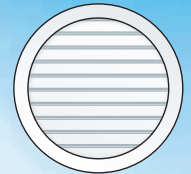
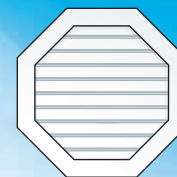
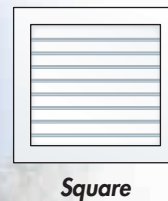
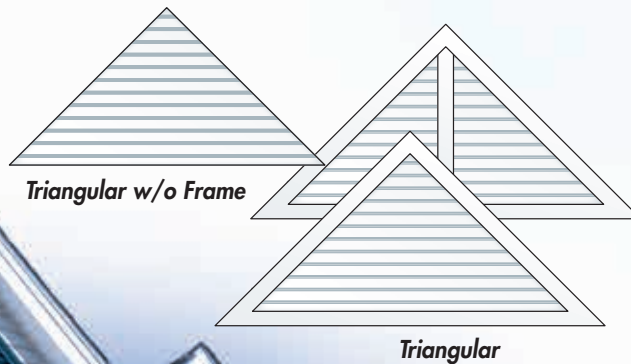

Make the ULTIMATE First Impression in your neighbourhood!

www.valor.ca

VALOR SPECIALTY PRODUCTS INC.

1800 Courtneypark Dr. East, Units 2-4
Mississauga, ON Canada L5T 1W1

TEL: (905) 564-3122 • FAX: (905) 564-5470



SPECIALTY PRODUCTS INC.

PVC Wall Accents / Sunbursts

PRODUCT	FORMAT	THICKNESS (IN)	SIZES (IN)
PVC Triangular Sunburst w/Recessed Grooves MWA110	Solid	0.625	Pitches: From 5/12 - 20/12 Widths: 36, 48, 60, 72, 84, 96
PVC Triangular Sunburst w/Batten Inserts MWA120	Solid	1.25	Pitches: From 5/12 - 20/12 Widths: 36, 48, 60, 72, 84, 96
PVC Triangular Sunburst w/V-Groove MWA130	Solid	1.50	Pitches: From 5/12 - 20/12 Widths: 36, 48, 60, 72, 84, 96
PVC Half Round w/Flutes MWA210	Solid	1.50	12.75 x 24, 14.75 x 28, 16.75 x 32, 18.75 x 36, 20.75 x 40, 22.75 x 44, 24.75 x 48, 27.75 x 54, 30.75 x 60, 36.75 x 72, 42.75 x 84
PVC Half Round w/RSD Panels MWA220	Solid	1.50	12.75 x 24, 14.75 x 28, 16.75 x 32, 18.75 x 36, 20.75 x 40, 22.75 x 44, 24.75 x 48, 27.75 x 54, 30.75 x 60, 36.75 x 72, 42.75 x 84
PVC Octagon w/REC Panels MWA310	Solid	1.50	24, 28, 32, 36, 40, 44
PVC Octagon w/9-Lite Grill MWA320	Solid	1.50	24, 28, 32, 36, 40, 44
PVC Octagon w/RSD Panels MWA330	Solid	1.50	24, 28, 32, 36, 40, 44
PVC Round w/REC Panels MWA410	Solid	1.50	24, 28, 32, 36, 40, 44
PVC Round w/9-Lite Grill MWA420	Solid	1.50	24, 28, 32, 36, 40, 44
PVC Round w/RSD Panels MWA430	Solid	1.50	24, 28, 32, 36, 40, 44
PVC Triangular Half Round Shake MWA510	Solid	0.625	Pitch: 10/12 22.0 x 52.8, 36.0 x 86.4 Pitch: 12/12 26.0 x 52.0, 42.0 x 84.0

*** PREMIUMS Charged for Custom & Extra Large Sizes.**

Solid = Solid PVC Construction

Note: Larger size Wall Accents indicated within outlined area, will be produced (and may be shipped) in 2-Sections, utilizing a vertical batten to cover the joint.

Custom Sizes Available

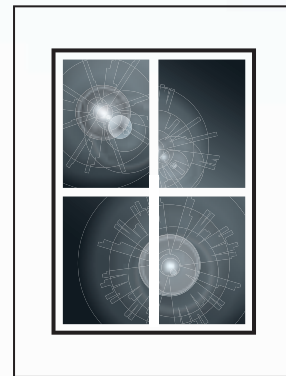

Custom Black-out Windows Available:

- Can be designed to closely match frame and sash configurations
- Can include Muntins
- Utilizes High Gloss Black Reflective ACM material
- No Glass to break, easy to clean
- No Internal film to deteriorate

Make the ULTIMATE First Impression in your neighbourhood!

www.valor.ca

VALOR SPECIALTY PRODUCTS INC.

1800 Courtneypark Dr. East, Units 2-4

Mississauga, ON Canada L5T 1W1

TEL: (905) 564-3122 • FAX: (905) 564-5470

PVC Wall Accents / Sunbursts

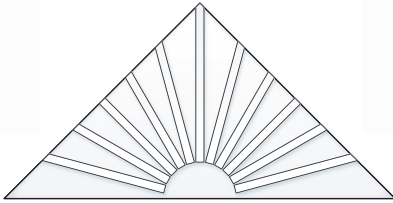

MWA-110

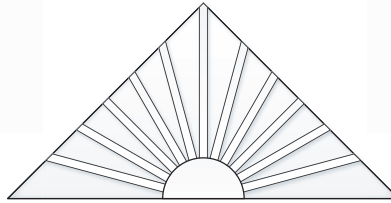

MWA-120

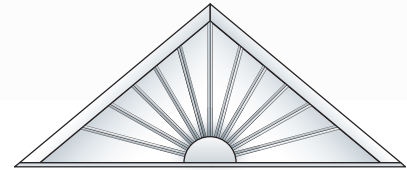

MWA-130

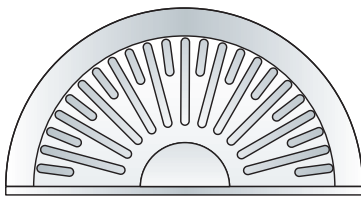

MWA-210

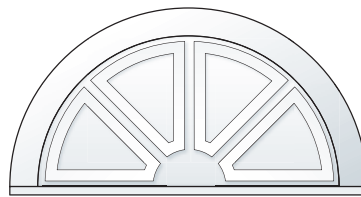

MWA-220

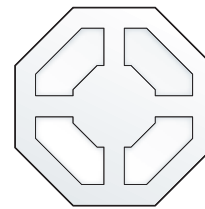

MWA-310

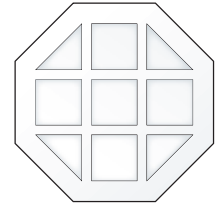

MWA-320

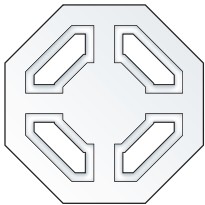

MWA-330

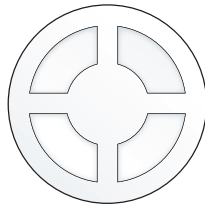

MWA-410

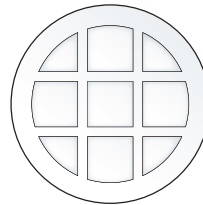

MWA-420

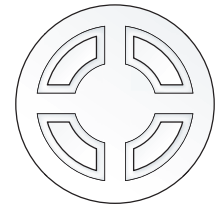

MWA-430

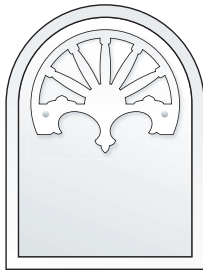

MWA-501

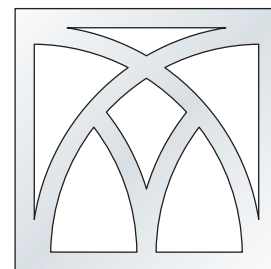
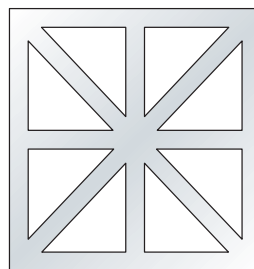

Custom Wall Panel Accents:

- Can be produced in any material thickness
- Virtually ANY design

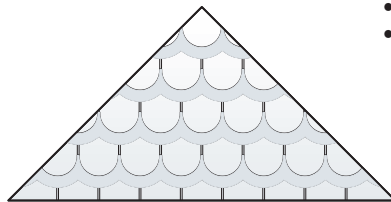

MWA-510

Make the ULTIMATE First Impression in your neighbourhood!

www.valor.ca

VALOR SPECIALTY PRODUCTS INC.

1800 Courtneypark Dr. East, Units 2-4
Mississauga, ON Canada L5T 1W1

TEL: (905) 564-3122 • FAX: (905) 564-5470

PVC Headers

PRODUCT	TYPE (TYP)	THICKNESS (IN)	HEIGHTS (IN)	WIDTHS (IN)
PVC Header - Rake MHR-101	SQR - Square	Base: 0.75	5.50, 7.25	24, 30, 36, 42, 48, 54, 60, 66, 72, 78, 84, 96, 108, 120, 144
	BNS - Bullnose	Total: 1.875		
PVC Header - Rake Optional Keystone	Fits Both Types	-	5.50, 7.25	Fits All Widths
PVC Header - Crown w/Sill MHR-102	SQR - Square	Base: 0.75	5.50, 7.25	24, 30, 36, 42, 48, 54, 60, 66, 72, 78, 84, 96, 108, 120, 144
	BNS - Bullnose	Total: 3.00		
PVC Header - Crown w/Sill Optional Keystone	Fits Both Types	-	5.50, 7.25	Fits All Widths
PVC Header - Rams Crown MHR-103	SQR - Square	Base: 0.75	5.50, 7.25	24, 30, 36, 42, 48, 54, 60, 66, 72, 78, 84, 96, 108, 120, 144
	BNS - Bullnose	Total: 2.125		
PVC Header - Rams Crown Optional Keystone	Fits Both Types	-	5.50, 7.25	Fits All Widths
PVC Header - Smooth Crown w/Sill MHR-104	SQR - Square	Base: 0.75	5.50, 7.25	24, 30, 36, 42, 48, 54, 60, 66, 72, 78, 84, 96, 108, 120, 144
	BNS - Bullnose	Total: 3.00		
PVC Header - Smooth Crown w/Sill Optional Keystone	Fits Both Types	-	5.50, 7.25	Fits All Widths

*PREMIUMS Charged for Custom & Extra Large Sizes.
 SQR - Square Bottom Edge, BNS - Bullnose Bottom Edge
 Thickness: Base, TTL - Total Projection
 Custom sizes available.



MHR-1011
(Rake, w/SQR Edge)



Rake
Keystone



MHR-1012
(Rake, w/Bullnose Edge)



MHR-1021
(3.5" Crown, w/SQR Edge)



Crown Mould
Keystone



MHR-1022
(3.5" Crown, w/Bullnose Edge)



MHR-1031
(Rams Crown, w/SQR Edge)



Rams Crown
Keystone



MHR-1032
(Rams Crown, w/Bullnose Edge)



MHR-1041
(Smooth Crown, w/SQR Edge)



Smooth Crown
Keystone



MHR-1042
(Smooth Crown, w/Bullnose Edge)

Make the ULTIMATE First Impression in your neighbourhood!

www.valor.ca

VALOR SPECIALTY PRODUCTS INC.

1800 Courtneypark Dr. East, Units 2-4

Mississauga, ON Canada L5T 1W1

TEL: (905) 564-3122 • FAX: (905) 564-5470

PVC Pilasters



PRODUCT	TYPE (TYP)	THICKNESS (IN)	WIDTHS (IN)	HEIGHTS (IN)
PVC Pilaster - Fluted	FLT01	0.625	5.50, 7.25, 9.25, 11.25	84, 94
	FLT02			
	FLT03			
PVC Pilaster - Raised Panel	RPL01	0.625	5.50, 7.25, 9.25, 11.25	84, 94
	RPL02			
	RPL03			
PVC Pilaster - Recessed Panel	REC01	0.625	5.50, 7.25, 9.25, 11.25	84, 94
	REC02			
	REC03			
PVC Plinth Blocks (Pair)	-	0.625	5.50, 7.25, 9.25, 11.25	3.50, 5.50, 7.25, 9.25

* **PREMIUMS** Charged for Custom & Extra Large Sizes.
 SQR - Square Bottom Edge,
 BNS - Bullnose Bottom Edge
 Thickness: Base, TTL - Total Projection
 Custom Sizes Available

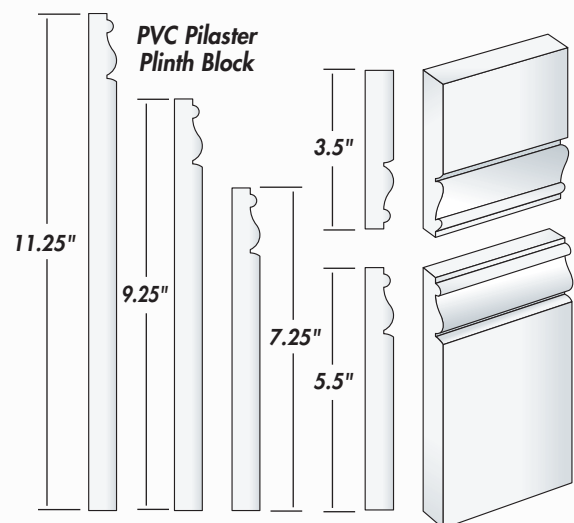
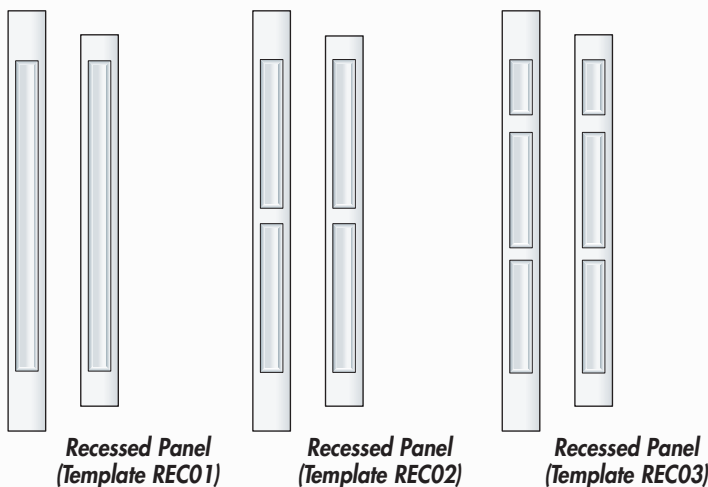
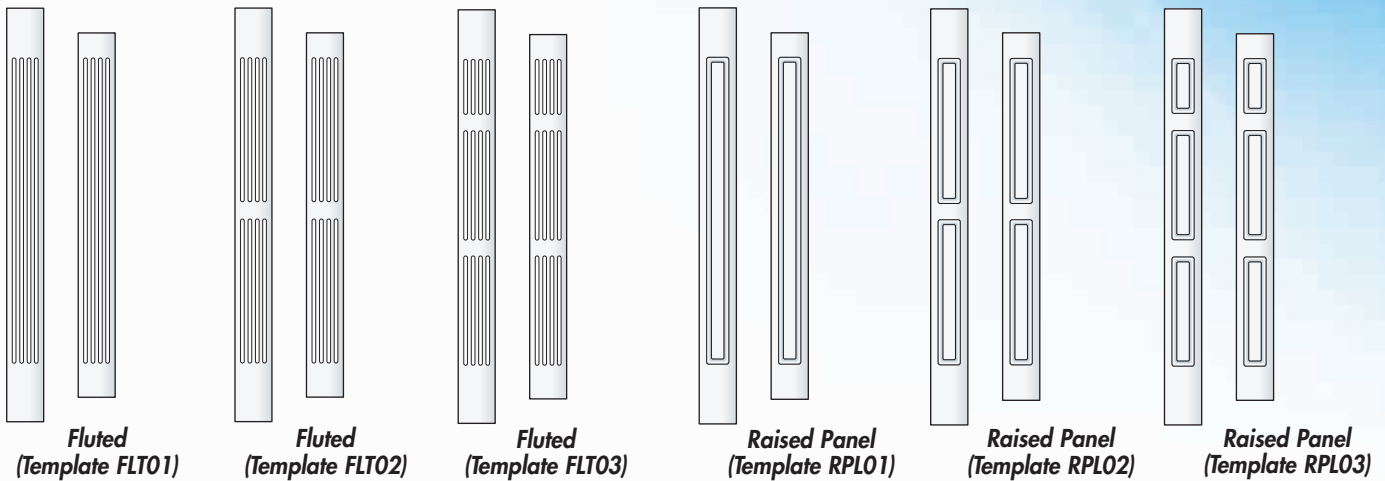

Make the ULTIMATE First Impression in your neighbourhood!

www.valor.ca

VALOR SPECIALTY PRODUCTS INC.

1800 Courtneypark Dr. East, Units 2-4

Mississauga, ON Canada L5T 1W1

TEL: (905) 564-3122 • FAX: (905) 564-5470



SPECIALTY PRODUCTS INC.

PVC Adjustable Pilaster Kits



PRODUCT	TYPE (TYP)	THICKNESS (IN)	SIZES (IN)	FITS HEIGHTS (IN)
PVC Adjustable Pilaster - Fluted	FLT01	1.50	7.00 x 94.00, 7.00 x 114.00	84 - 94, 94 - 114
	FLT02		8.75 x 94.00, 8.75 x 114.00	84 - 94, 94 - 114
	FLT03		10.75 x 94.00, 10.75 x 114.00	84 - 94, 94 - 114
PVC Adjustable Pilaster - Raised Panel	RPL01	1.50	7.00 x 94.00, 7.00 x 114.00	84 - 94, 94 - 114
	RPL02		8.75 x 94.00, 8.75 x 114.00	84 - 94, 94 - 114
	RPL03		10.75 x 94.00, 10.75 x 114.00	84 - 94, 94 - 114
PVC Adjustable Pilaster - Recessed Panel	REC01	1.50	7.00 x 94.00, 7.00 x 114.00	84 - 94, 94 - 114
	REC02		8.75 x 94.00, 8.75 x 114.00	84 - 94, 94 - 114
	REC03		10.75 x 94.00, 10.75 x 114.00	84 - 94, 94 - 114

Kits Include, 2-Pilasters, 2-Moveable & Trimable Plinth Blocks
 *PREMIUMS Charged for Custom & Extra Large Sizes.
 Custom Sizes Available

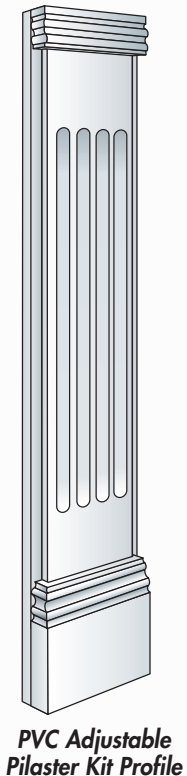

PVC Adjustable Pilaster Kit Profile

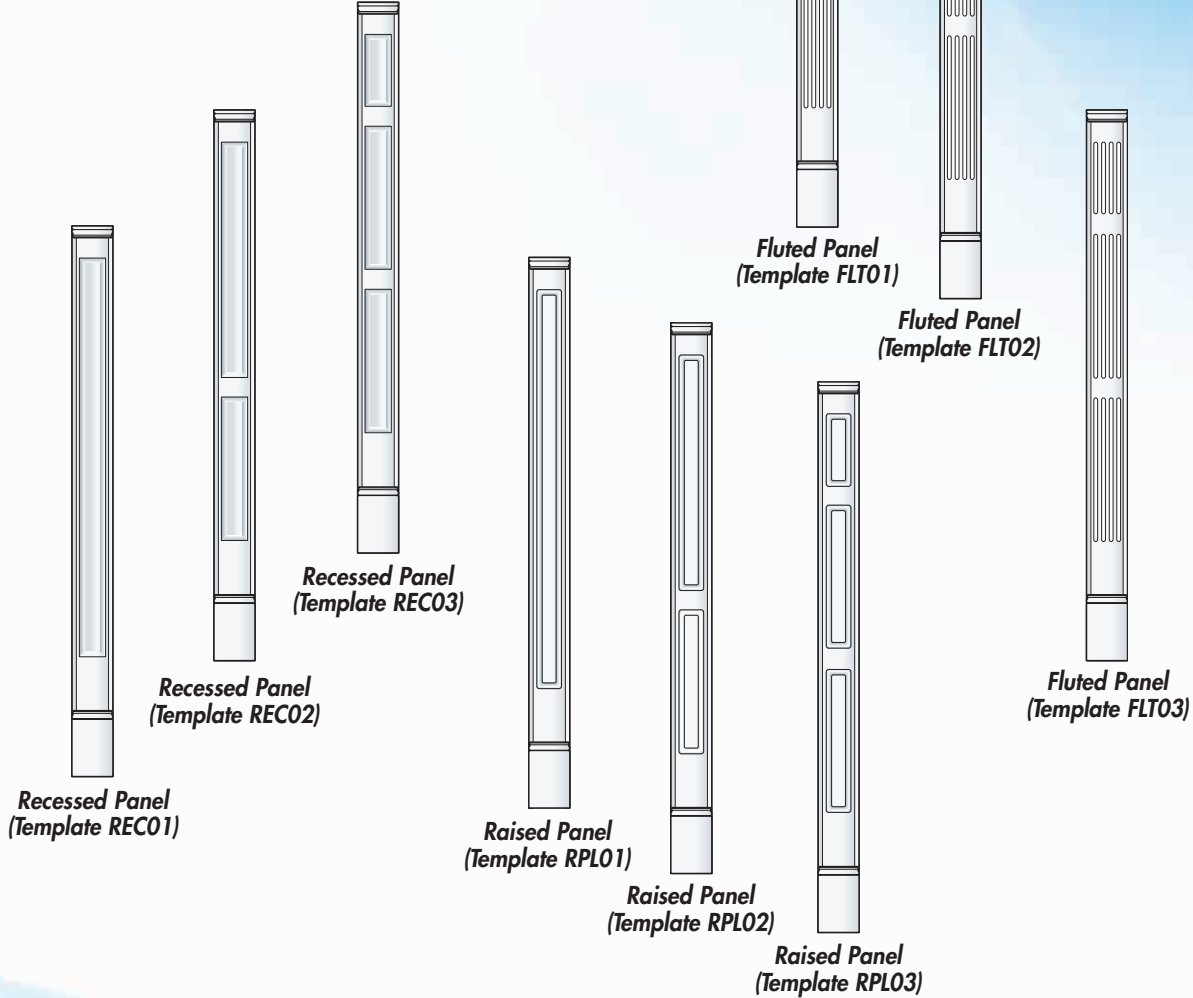

Recessed Panel (Template REC01)

Recessed Panel (Template REC02)

Recessed Panel (Template REC03)

Raised Panel (Template RPL01)

Raised Panel (Template RPL02)

Raised Panel (Template RPL03)

Fluted Panel (Template FLT01)

Fluted Panel (Template FLT02)

Fluted Panel (Template FLT03)

Make the ULTIMATE First Impression in your neighbourhood!

www.valor.ca

VALOR SPECIALTY PRODUCTS INC.
 1800 Courtneypark Dr. East, Units 2-4
 Mississauga, ON Canada L5T 1W1
 TEL: (905) 564-3122 • FAX: (905) 564-5470

PVC Mouldings

PRODUCT	STYLE	SIZES (IN)	LENGTHS (IN)
Crown 3.50in Frieze - Adjustable Height	SQR, BNS	2.75 x 5.50 - 7.50	144
	SQR, BNS	2.75 x 7.25 - 9.20	144
	SQR, BNS	2.75 x 9.25 - 11.20	144
PVC Moulding Frieze (Typ:01)	SQR	2.50 x 9.25	144
PVC Fleur-De-Lis	-	0.75 x 7.50	96
Dentil Moulding - SQR Edge w/3.5in Square Tooth	SQR	1.50 x 5.50, 1.50 x 7.25, 1.50 x 9.25	144
Dentil Moulding - BNS Edge w/3.5in Square Tooth	BNS	1.50 x 5.50, 1.50 x 7.25, 1.50 x 9.25	144
Dentil Moulding - SQR Edge w/4.5in Square Tooth	SQR	1.50 x 5.50, 1.50 x 7.25, 1.50 x 9.25	144
Dentil Moulding - BNS Edge w/4.5in Square Tooth	BNS	1.50 x 5.50, 1.50 x 7.25, 1.50 x 9.25	144
Dentil Moulding - SQR Edge w/5.5in Square Tooth	SQR	1.50 x 5.50, 1.50 x 7.25, 1.50 x 9.25	144
Dentil Moulding - BNS Edge w/5.5in Square Tooth	BNS	1.50 x 5.50, 1.50 x 7.25, 1.50 x 9.25	144
Dentil Moulding - SQR Edge w/5.25in Half RND Tooth	SQR	1.50 x 5.50, 1.50 x 7.25, 1.50 x 9.25	144
Dentil Moulding - BNS Edge w/5.25in Half RND Tooth	BNS	1.50 x 5.50, 1.50 x 7.25, 1.50 x 9.25	144
Dentil Strip - 3.50in SQR Tooth	-	0.75 x 3.50	48
Dentil Strip - 4.25in SQR Tooth	-	0.75 x 4.25	48
Dentil Strip - 5.25in SQR Tooth	-	0.75 x 5.25	48
Dentil Strip - 5.25in Half RND Tooth	-	0.75 x 5.25	48

* PREMIUMS Charged for Custom & Extra Large Sizes.
SQR - Square Edge, BNS - Bullnose Edge
Custom Sizes Available

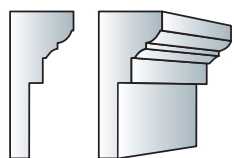
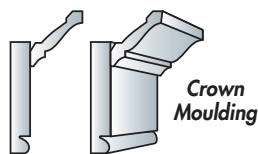

Dentil Frieze
MMD-120110144 / MMD-120110144



Fleur-De-Lis - MMD-140080096



Dentil Strip - MMD-151075048



Dentil Frieze-w/Bullnose
MMD-151108144 / MMD-120110144



Dentil Frieze
MMD-152008144 / MMD-152010144



Dentil Strip - MMD-152075048



Dentil Frieze-w/Bullnose
MMD-152108144 / MMD-152110144



Dentil Frieze - MMD-153004144



Dentil Frieze - MMD-153006144



Dentil Strip - MMD-153075048



Dentil Frieze-w/Bullnose - MMD-153106144



Dentil Frieze-w/Bullnose - MMD-153108144



Dentil Frieze - MMD-154004144



Dentil Frieze - MMD-154006144

Make the ULTIMATE First Impression in your neighbourhood!

www.valor.ca

VALOR SPECIALTY PRODUCTS INC.

1800 Courtneypark Dr. East, Units 2-4

Mississauga, ON Canada L5T 1W1

TEL: (905) 564-3122 • FAX: (905) 564-5470

VALOR

SPECIALTY PRODUCTS INC.

PVC Brackets & Accents

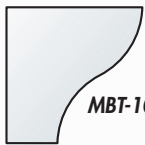

MBT-102040404



MBT-103060623
MBT-103060606

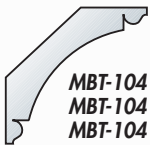

MBT-104141430
MBT-104161630
MBT-104181830

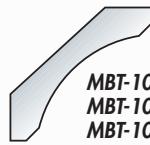

MBT-105121220 / 30
MBT-105141420 / 30
MBT-105181820 / 30

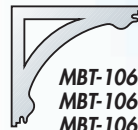

MBT-106121215
MBT-106141415
MBT-106161615

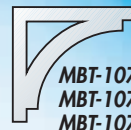

MBT-107121215
MBT-107141415
MBT-107161615



MBT-108141050
MBT-108142250
MBT-108142450

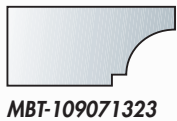

MBT-109071323

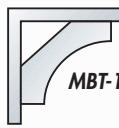

MBT-10101010

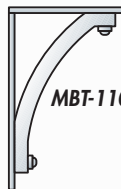

MBT-110152404



MBT-111155110



MBT-112091330



MBT-113152030



MBT-114142240

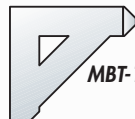

MBT-115151404



MBT-116090903



MBT-116110903



MBT-117203230



MBT-118060660



MBT-201171508



MBT-202091508
MBT-202122008



MBT-203231608

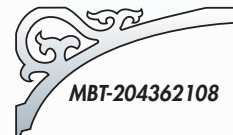

MBT-204362108

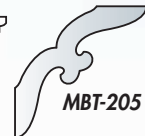

MBT-205121208

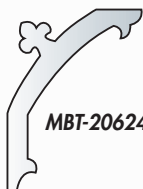

MBT-206241808



MBT-207162908



MBT-208221208



MBT-209103108



MBT-210072408



MBT-211123008



MBT-815225096

Make the ULTIMATE First Impression in your neighbourhood!

www.valor.ca

VALOR SPECIALTY PRODUCTS INC.

1800 Courtneypark Dr. East, Units 2-4
Mississauga, ON Canada L5T 1W1

TEL: (905) 564-3122 • FAX: (905) 564-5470



SPECIALTY PRODUCTS INC.

PVC Brackets & Accents



PRODUCT	
MBT-101010010	PVC Bracket - Solid 10x10x3.5in
MBT-102040404	PVC Bracket 4.0x4.0x4.0in
MBT-103060623	PVC Bracket 5.50x6.25x2.25in
MBT-103060606	PVC Bracket 5.50x6.25x5.50in
MBT-104141430	PVC Bracket - Solid 14x14x3.0in
MBT-104161630	PVC Bracket-Solid 16x16x3.0in
MBT-104181830	PVC Bracket - Solid 18x18x3.0in
MBT-105121220	PVC Bracket - Solid 12x12x2.00in
MBT-105141420	PVC Bracket - Solid 14x14x2.00in
MBT-105181820	PVC Bracket - Solid 18x18x2.00in
MBT-105121230	PVC Bracket - Solid 12x12x3.00in
MBT-105141430	PVC Bracket - Solid 14x14x3.00in
MBT-105181830	PVC Bracket - Solid 18x18x3.00in
MBT-106121215	PVC Bracket - Solid 12x12x1.5in
MBT-106141415	PVC Bracket - Solid 14x14x1.5in
MBT-106161615	PVC Bracket - Solid 16x16x1.5in
MBT-107121215	PVC Bracket - Solid 12x12x1.5in
MBT-107141415	PVC Bracket - Solid 14x14x1.5in
MBT-107161615	PVC Bracket - Solid 16x16x1.5in
MBT-108141050	PVC Rafter End - Hollow 14x10x5in
MBT-108142250	PVC Rafter End - Hollow 14x22x5in
MBT-108142450	PVC Rafter End - Hollow 14x24x5in
MBT-109071323	PVC Rafter End - Hollow 7x13.5x2.25in

PRODUCT	
MBT-110152404	PVC Bracket - Solid 15.0x24x3.50in
MBT-111155110	PVC Bracket - Beam/Column 14.5x50.5x0.75in
MBT-112091330	PVC Bracket - Hollow 9.25x13.00x3.00in
MBT-113152030	PVC Bracket - Hollow 15.00x20.00x3.00in
MBT-114142240	PVC Bracket - Hollow 14.00x22.00x4.00in
MBT-115141504	PVC Bracket - Hollow 15.0x13.5x3.50in
MBT-116090903	PVC Bracket - Hollow 8.5x8.5x3.0in
MBT-116110903	PVC Bracket - Hollow 10.5x8.5x3.0in
MBT-117203230	PVC Bracket - Solid 20x32x3.0in
MBT-118060660	PVC Bracket - Hollow 5.5x5.5x12.0in
MBT-201171508	PVC Bracket - Solid 16.9x15.4x0.75in
MBT-202091508	PVC Bracket - Solid 8.5x14.9x0.75in
MBT-202122008	PVC Bracket - Solid 11.6x20.4x0.75in
MBT-203231608	PVC Bracket - Solid 23.4x16.1x0.75in
MBT-204362108	PVC Bracket - Solid 36.1x20.8x0.75in
MBT-205121208	PVC Bracket - Solid 12x12x0.75in
MBT-206241808	PVC Bracket - Solid 24x17.8x0.75in
MBT-207162908	PVC Bracket - Solid 16x29x0.75in
MBT-208221208	PVC Gable Trim - Solid 22x12x0.75in
MBT-209103108	PVC Gable Trim - Solid 10.2x31.4x0.75in
MBT-210072408	PVC Gable Trim - Solid 6.5x23.9x0.75in
MBT-211123008	PVC Gable Trim - Solid 11.7x30x0.75in
MBT-815225096	PVC Bracket/Scroll Channel 1.50x2.25x96.00in



Make the ULTIMATE First Impression in your neighbourhood!

www.valor.ca

VALOR SPECIALTY PRODUCTS INC.

1800 Courtneypark Dr. East, Units 2-4
Mississauga, ON Canada L5T 1W1

TEL: (905) 564-3122 • FAX: (905) 564-5470

Custom PVC Products

- Virtually any custom shape can be produced with the correct measurements.
- Products can be multi-layered and profiled parts
- Some Items may require Framing Templates
- All products will be quoted on an individual basis.

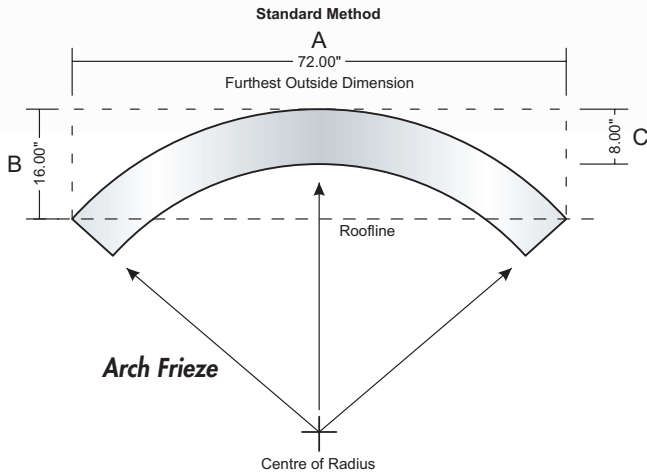

Round Top Custom Curved Gable Fascia Board

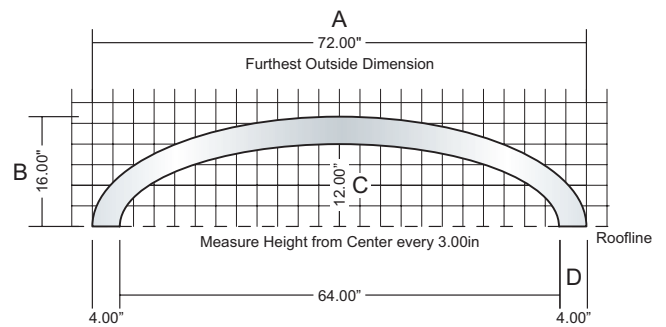
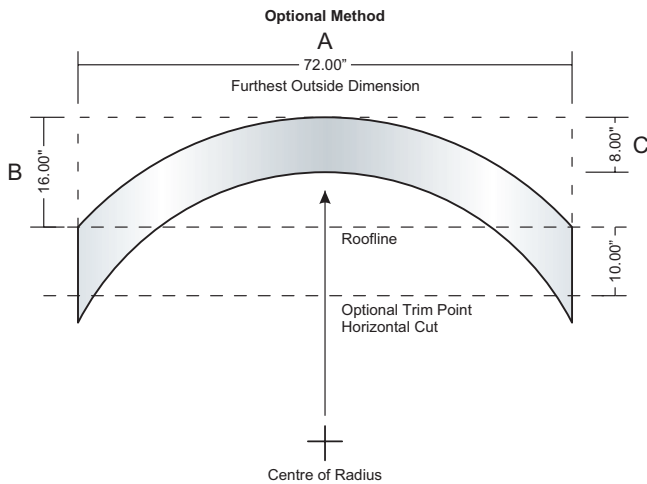
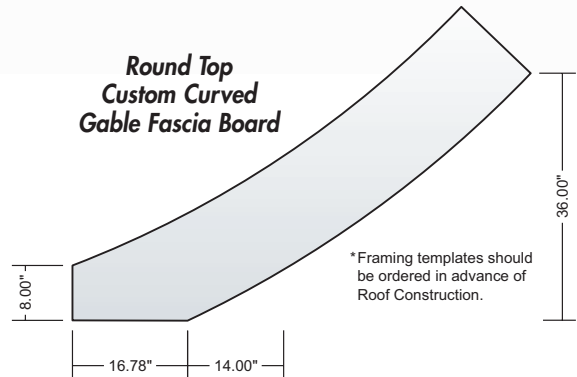

Frieze Board Type - Elliptical

PVC Cladding Beam Applications

PVC Cladding Beam Applications

PVC Cladding Facade

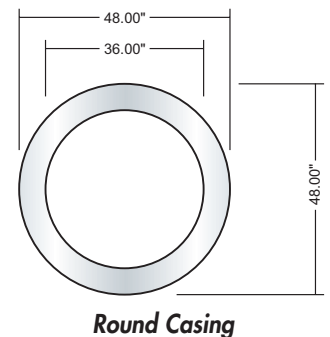
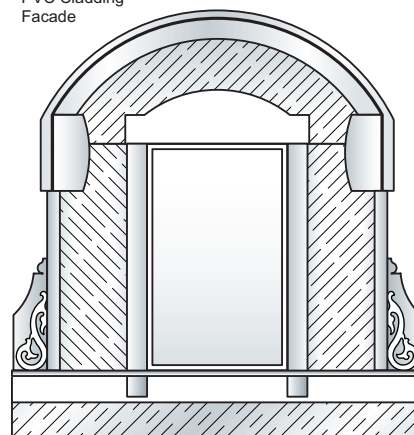
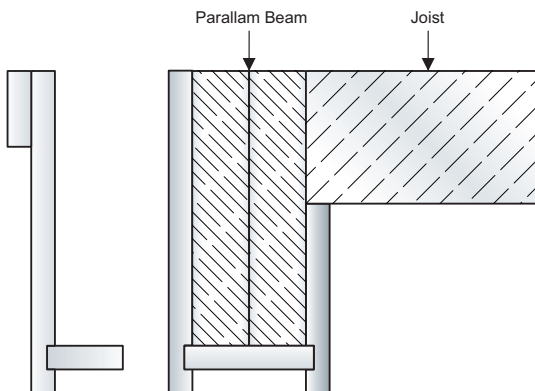

Round Casing

Make the **ULTIMATE** First Impression in your neighbourhood!

www.valor.ca

VALOR SPECIALTY PRODUCTS INC.

1800 Courtneypark Dr. East, Units 2-4
Mississauga, ON Canada L5T 1W1

TEL: (905) 564-3122 • FAX: (905) 564-5470

VALOR

SPECIALTY PRODUCTS INC.



Paint Services

Paint

Valor uses only Low VOC (volatile organic content) waterbase paint. We've selected paint specifically developed to provide superior adhesion to plastic substrates and hardness. Valor has applied this product since 2006 with excellent results.

Process

All products go through a multi-stage preparation process to ensure superior adhesion to the product.

Application

Valor utilizes the most advance HVLP guns for application of paint. Some colour pigments require multiple wet coats where each coat needs to fully flash off before the next coat can be applied. Some colours will be applied at a premium to cover any additional costs.

**Heat Reflective**

Darker colours will have a heat reflective additive to reduce surface temperatures intended to reduce warping and expansion.

Gloss Level

Our paint is ordered with a 60% gloss, although we have specified large projects using material with larger surface area in MATT finish that would be approximately at 40% gloss.

Protection

All painted product is protected as required, with poly wrap, self-adhesive film, foam, or cardboard.

Paint Match

We can match any colour however due to match cost and the amount of paint required, we will charge a paint match fee.

Projects

Projects that will use greater than a gallon of paint will generally not have extra charges, however minimum charges will always apply.

Make the ULTIMATE First Impression in your neighbourhood!

www.valor.ca

VALOR SPECIALTY PRODUCTS INC.

1800 Courtneypark Dr. East, Units 2-4
Mississauga, ON Canada L5T 1W1

TEL: (905) 564-3122 • FAX: (905) 564-5470



VALOR

SPECIALTY PRODUCTS INC.

Maintenance Free...

- Custom Decorative Shutters
- Fiberglass Columns
- Exterior Mouldings
- Siding Accessories
- Custom PVC Millwork

Make the ULTIMATE First Impression in your neighbourhood!

www.valor.ca

VALOR SPECIALTY PRODUCTS INC.

1800 Courtneypark Dr. East, Units 2 - 4
Mississauga, ON Canada L5T 1W1
TEL: (905) 564-3122 • FAX: (905) 564-5470